



US0D1019741S

(12) **United States Design Patent**
Deng

(10) **Patent No.:** **US D1,019,741 S**

(45) **Date of Patent:** **** Mar. 26, 2024**

(54) **PROJECTOR**

(71) Applicant: **Shenzhen Shadow Crown Technology Co., Ltd**, Guangdong (CN)

(72) Inventor: **Feiyue Deng**, Guangdong (CN)

(**) Term: **15 Years**

(21) Appl. No.: **29/851,242**

(22) Filed: **Aug. 26, 2022**

(30) **Foreign Application Priority Data**

Jun. 24, 2022 (CN) 202230394590.6

(51) **LOC (14) Cl.** **16-02**

(52) **U.S. Cl.**

USPC **D16/230; D16/225**

(58) **Field of Classification Search**

USPC D16/221, 225, 229, 230, 231, 234;
D21/514; D14/506, 509, 172, 204, 215,
D14/216

CPC G03B 21/16; G03B 21/145; G03B 21/00;
G03B 21/001; G03B 21/003; G03B 21/14

See application file for complete search history.

(56) **References Cited**

U.S. PATENT DOCUMENTS

D948,595 S * 4/2022 Wu D16/225
D957,505 S * 7/2022 Peng D16/230

D963,734 S * 9/2022 Wu D16/230
D998,684 S * 9/2023 Chen D16/230
D1,001,871 S * 10/2023 Gao D16/230
D1,003,976 S * 11/2023 Kim D16/225
2020/0186763 A1* 6/2020 Chen G03B 21/16

* cited by examiner

Primary Examiner — Wan Laymon

(57) **CLAIM**

The ornamental design for a projector, as shown and described.

DESCRIPTION

FIG. 1 is a front and top perspective view of a projector, showing my new design;

FIG. 2 is a rear and bottom perspective view thereof;

FIG. 3 is a front elevation view thereof;

FIG. 4 is a rear elevation view thereof;

FIG. 5 is a left side elevation view thereof;

FIG. 6 is a right side elevation view thereof;

FIG. 7 is a top plan view thereof;

FIG. 8 is a bottom plan view thereof; and,

FIG. 9 is an enlarged perspective view of detail “9” identified in FIG. 1.

The dashed lines in the figures illustrate portions of the projector that form no part of the claimed design. The dash dot dash lines in FIGS. 1 and 9 are for the purpose of illustrating the enlarged view indicators and form no part of the claimed design.

1 Claim, 9 Drawing Sheets

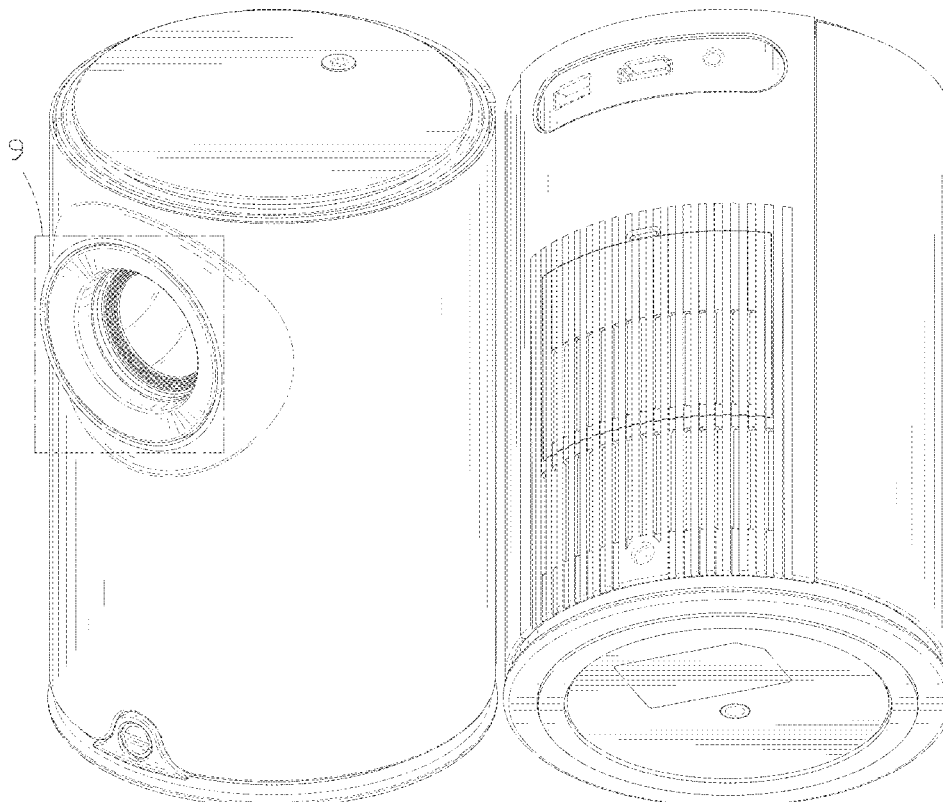

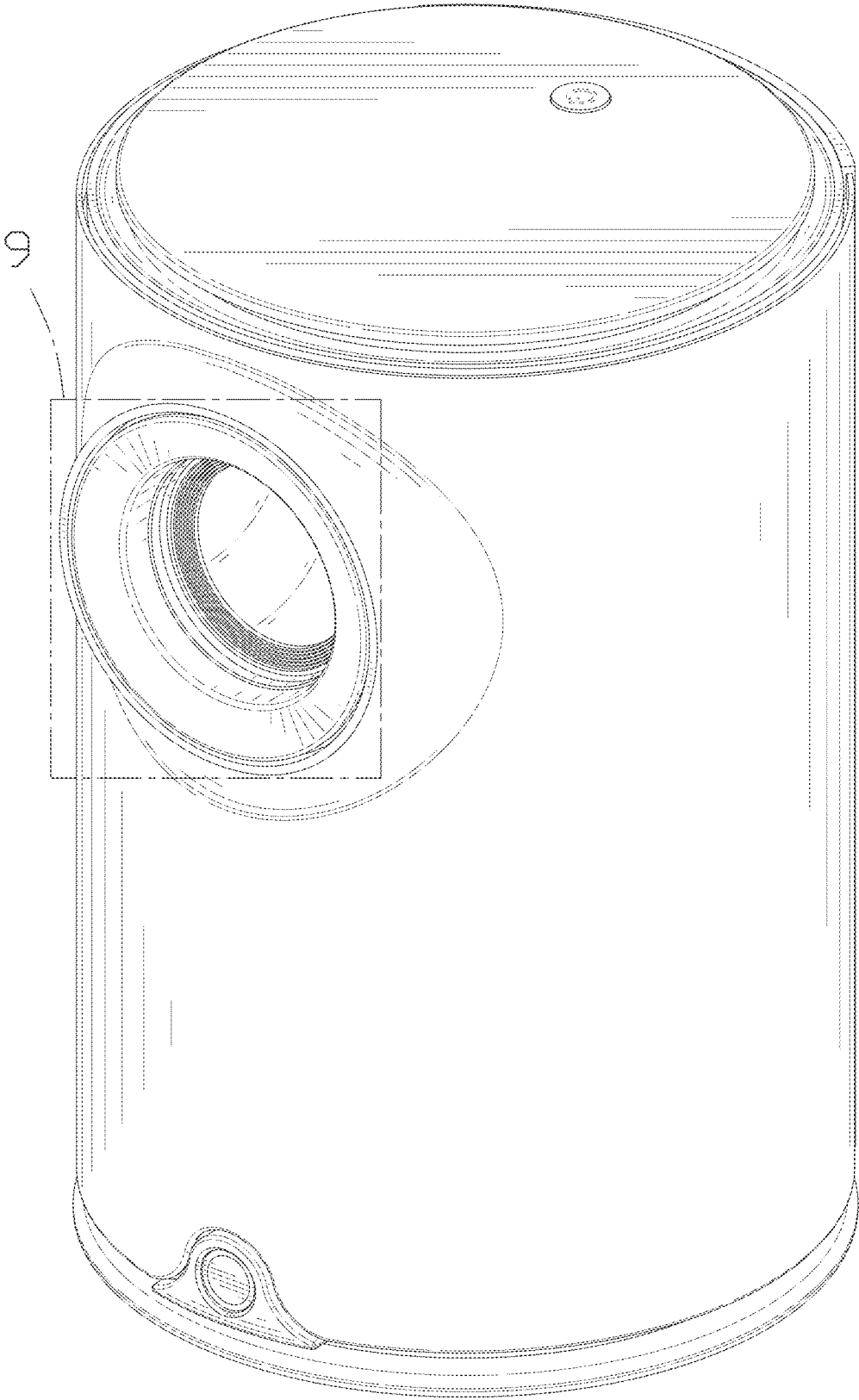

FIG. 1

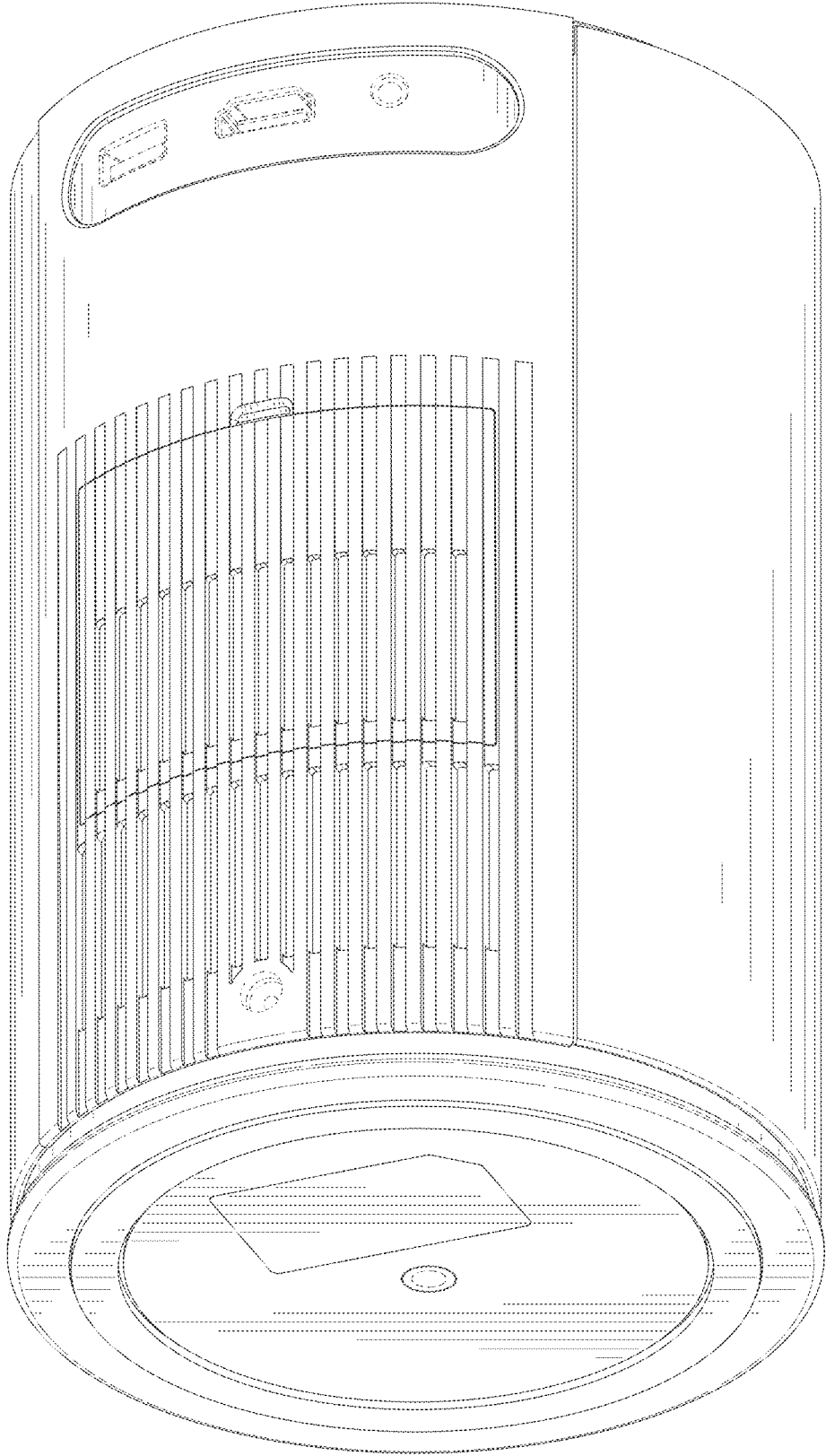

FIG. 2

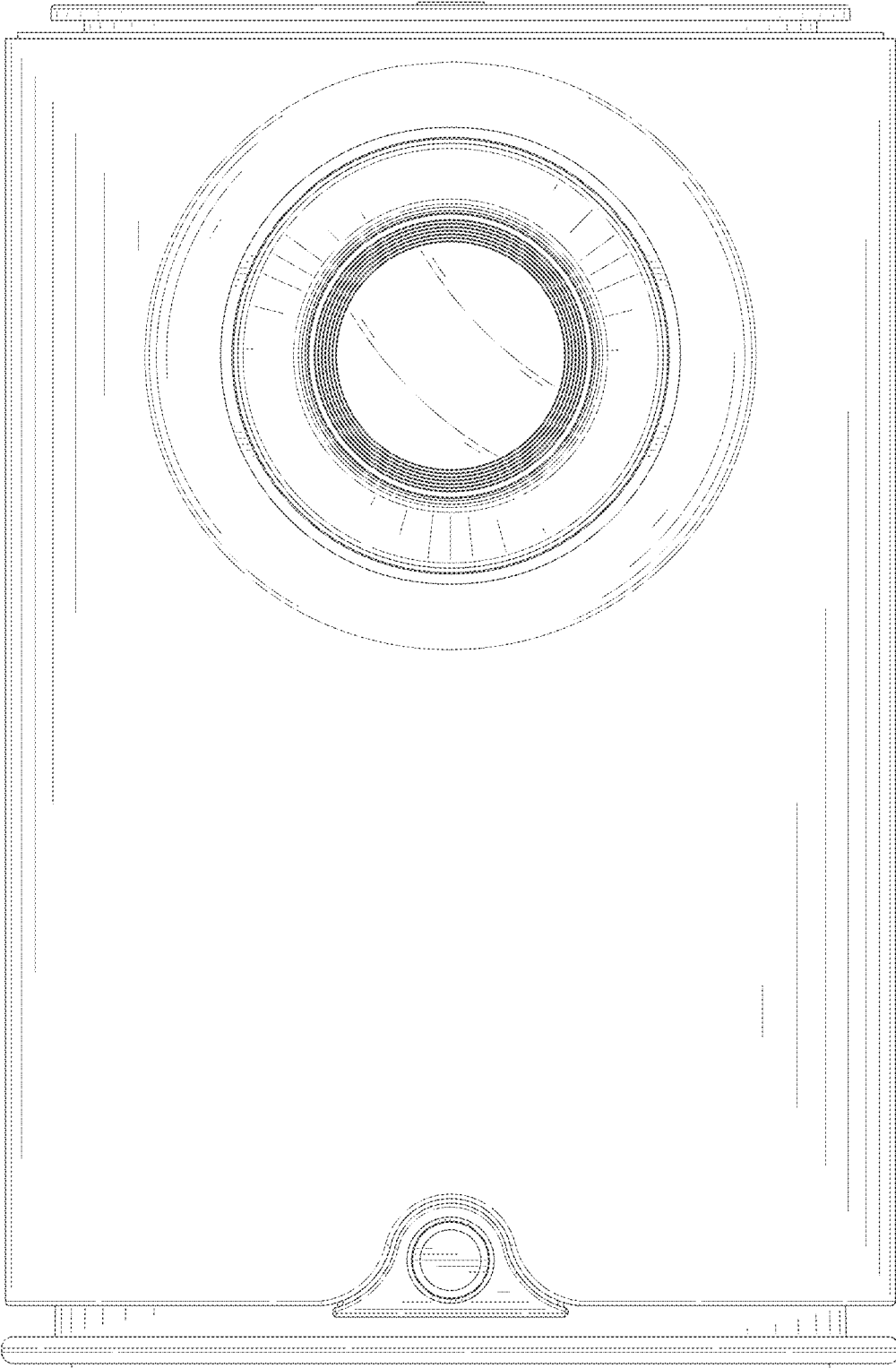

FIG. 3

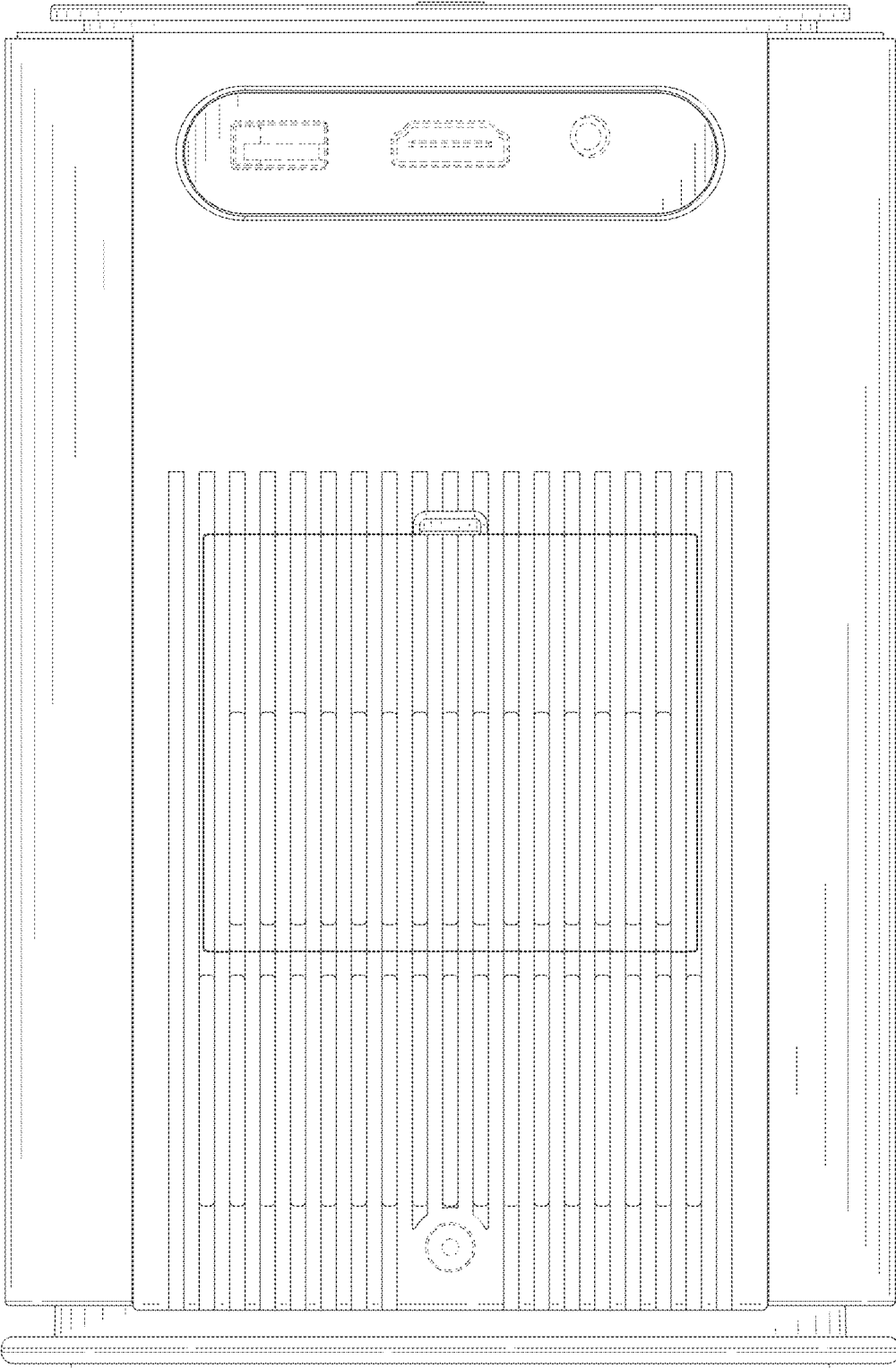

FIG. 4

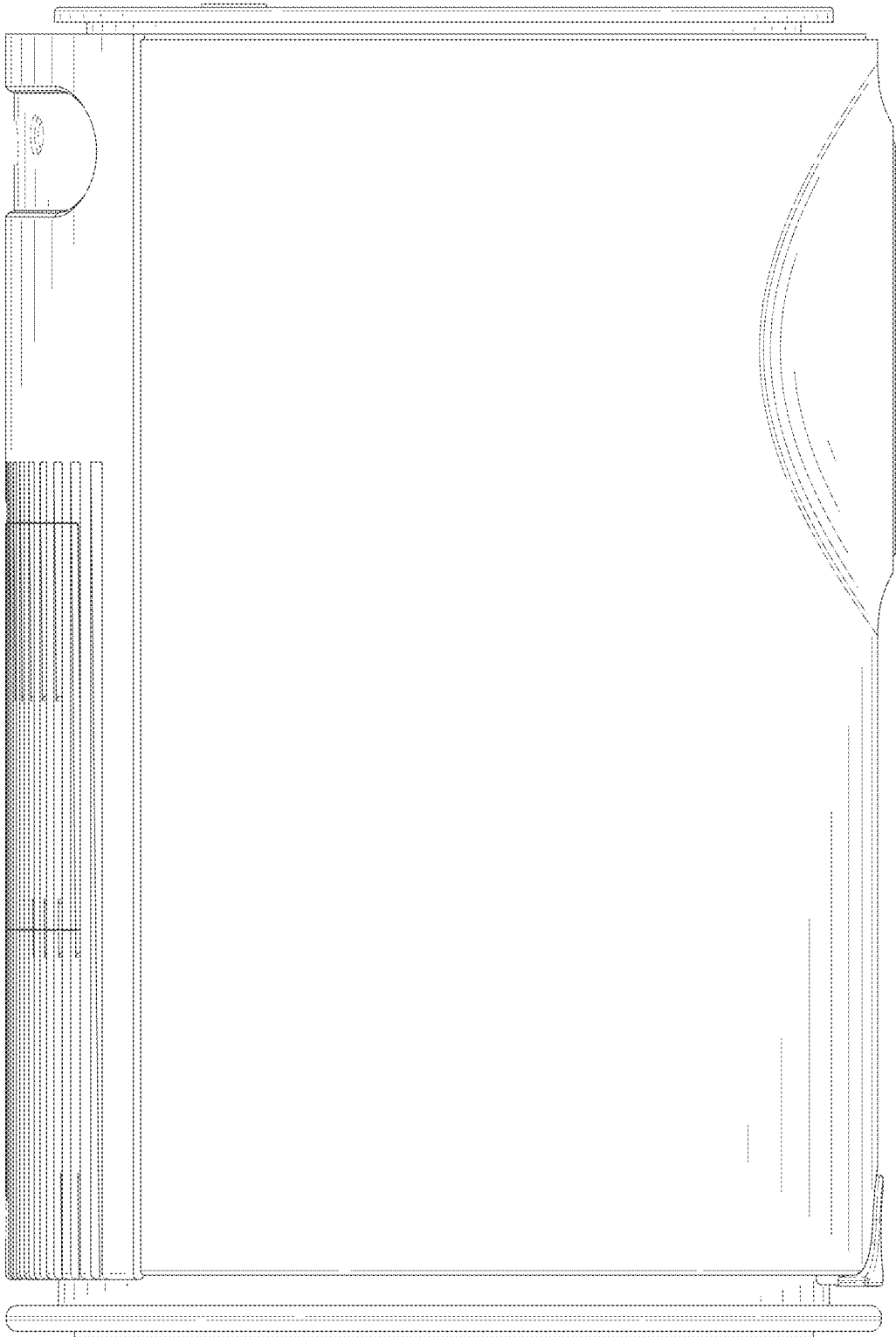

FIG. 5



FIG. 6

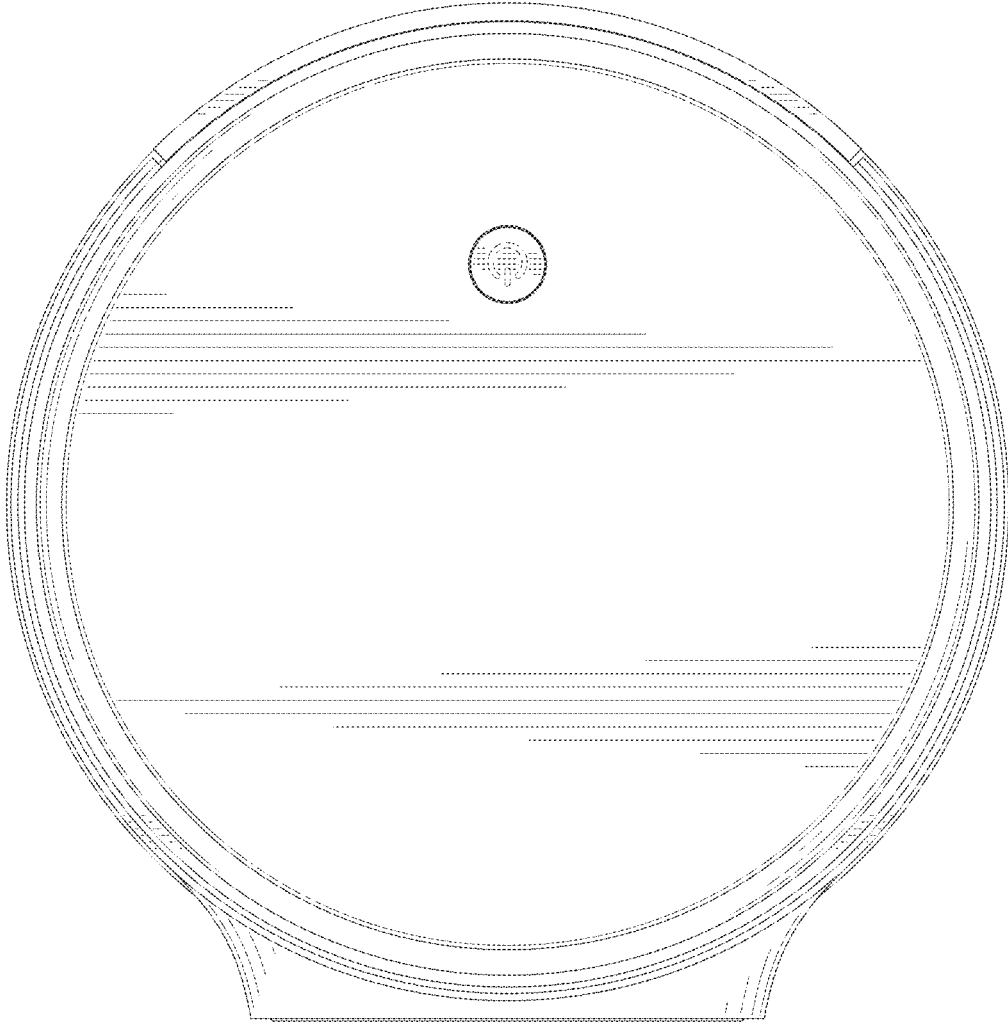

FIG. 7

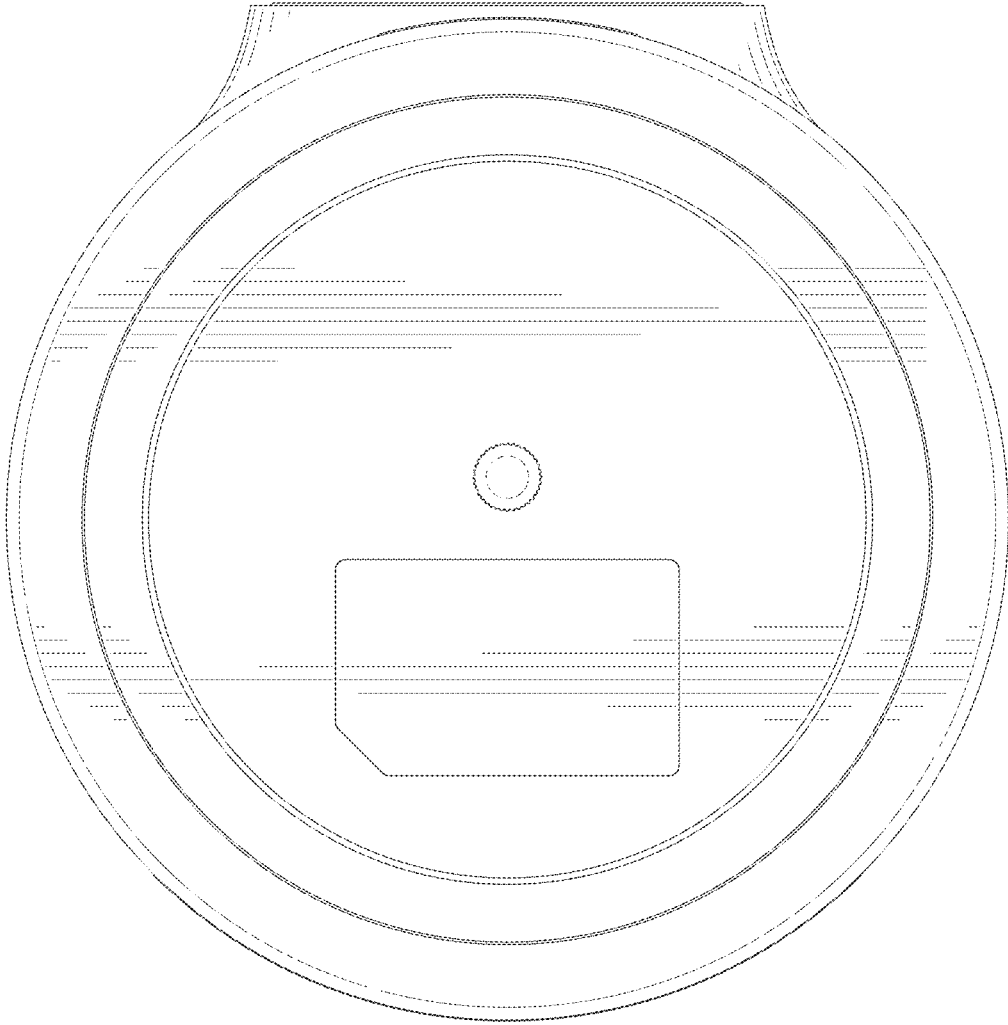

FIG. 8

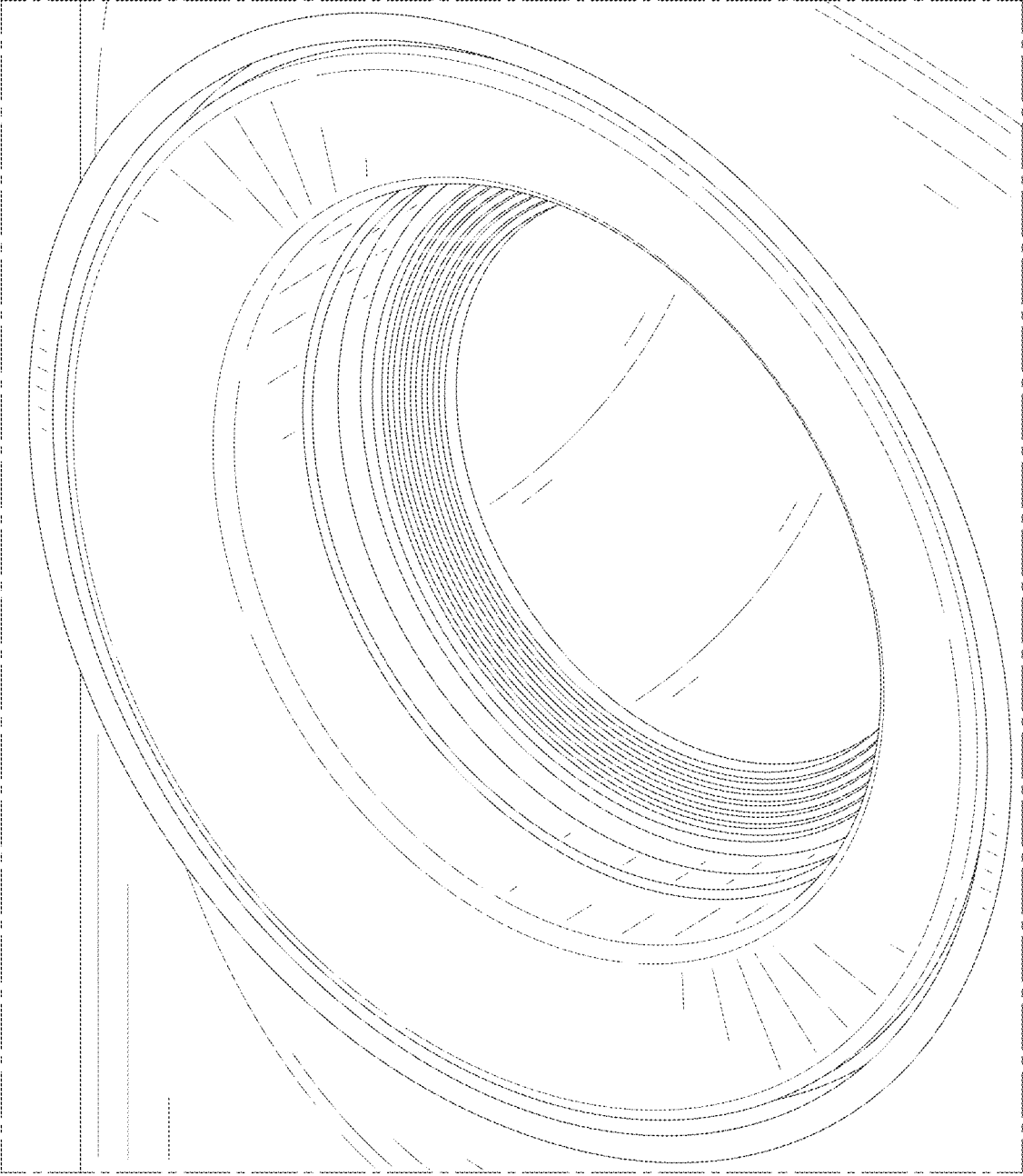

FIG. 9