



US00D791298S

(12) **United States Design Patent**  
**Farhan et al.**

(10) **Patent No.:** **US D791,298 S**  
(45) **Date of Patent:** **\*\* Jul. 4, 2017**

- (54) **ARCHITECT AIR PURIFICATION UNIT**
- (71) Applicant: **HGI Industries, Inc.**, Boynton Beach, FL (US)
- (72) Inventors: **Muhammad Farhan**, Wyong (AU); **Richard Mariusz Bystrzynski**, Merrylands (AU); **Adrian Philip Lake**, Ourimbah (AU); **Rory Le Maistre Wilson**, Mordale (AU)
- (73) Assignee: **HGI Industries, Inc.**, Boynton Beach, FL (US)

- 3,999,969 A \* 12/1976 Shuler ..... B01D 46/00 55/418
- 4,389,827 A \* 6/1983 Van Valkenburg ..... F24F 13/20 454/201
- 5,037,586 A \* 8/1991 Mehrholz ..... F24F 6/04 261/142
- 5,240,653 A \* 8/1993 Ramkissoon ..... A61L 9/12 239/56
- D355,482 S \* 2/1995 Grigsby, Jr. .... D15/5
- 5,525,145 A \* 6/1996 Hodge ..... B01D 46/001 454/309
- D394,901 S \* 6/1998 Governale ..... D23/351
- D416,315 S \* 11/1999 Nanjo ..... D23/351
- D448,462 S \* 9/2001 Nanjo ..... D23/351
- D557,781 S \* 12/2007 Kim ..... D23/351
- 7,651,390 B1 \* 1/2010 Profeta ..... F24F 13/06 454/284
- D617,442 S \* 6/2010 Grages ..... D23/393

(\*\*) Term: **15 Years**

(21) Appl. No.: **29/546,619**

(22) Filed: **Nov. 24, 2015**

(51) **LOC (10) Cl.** ..... **23-04**

(52) **U.S. Cl.**  
USPC ..... **D23/364**

(58) **Field of Classification Search**  
USPC ..... D23/333, 355-364, 385, 388, 393  
CPC ..... A61M 16/16; A61M 16/0816; A61M 16/0003; F24F 2006/008; F24F 3/1405; F24F 2003/144; F24F 11/0008; F24F 13/28

See application file for complete search history.

(56) **References Cited**

**U.S. PATENT DOCUMENTS**

- 2,008,751 A \* 7/1935 Davies ..... B01D 46/00 55/491
- 2,296,566 A \* 9/1942 Neumann ..... B01D 46/00 210/494.2
- D152,122 S \* 12/1948 Ohm ..... D23/385
- 3,003,581 A \* 10/1961 Greason ..... B01D 46/10 55/512
- D234,692 S \* 4/1975 Laakkonen ..... D23/364

(Continued)

*Primary Examiner* — Kevin Rudzinski

*Assistant Examiner* — John Reickel

(74) *Attorney, Agent, or Firm* — Jon Gibbons; Fleit Gibbons Gutman Bongini & Bianco, P.L.

(57) **CLAIM**

The ornamental design for an architect air purification unit, as shown and described.

**DESCRIPTION**

FIG. 1 is perspective view of the architect air purification unit;  
FIG. 2 is a front elevational view thereof;  
FIG. 3 is a rear elevational view thereof;  
FIG. 4 is a left side elevational view thereof;  
FIG. 5 is a right side elevational view thereof;  
FIG. 6 is a top plan view thereof; and,  
FIG. 7 is a bottom plan view thereof.

The broken line showing of an architect air purification unit is included for the purpose of illustrating portions of the article and forms no part of the claimed design.

**1 Claim, 5 Drawing Sheets**

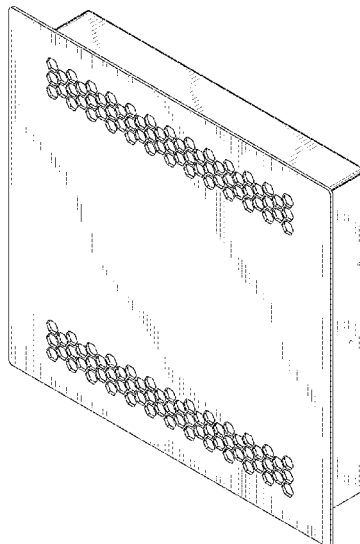

(56)

**References Cited**

U.S. PATENT DOCUMENTS

8,460,075	B2 *	6/2013	Mavroudis .....	F24F 13/084 454/275
D728,766	S *	5/2015	Kim .....	D23/351
2010/0025485	A1 *	2/2010	Kaneiwa .....	F24H 9/0063 237/53

\* cited by examiner

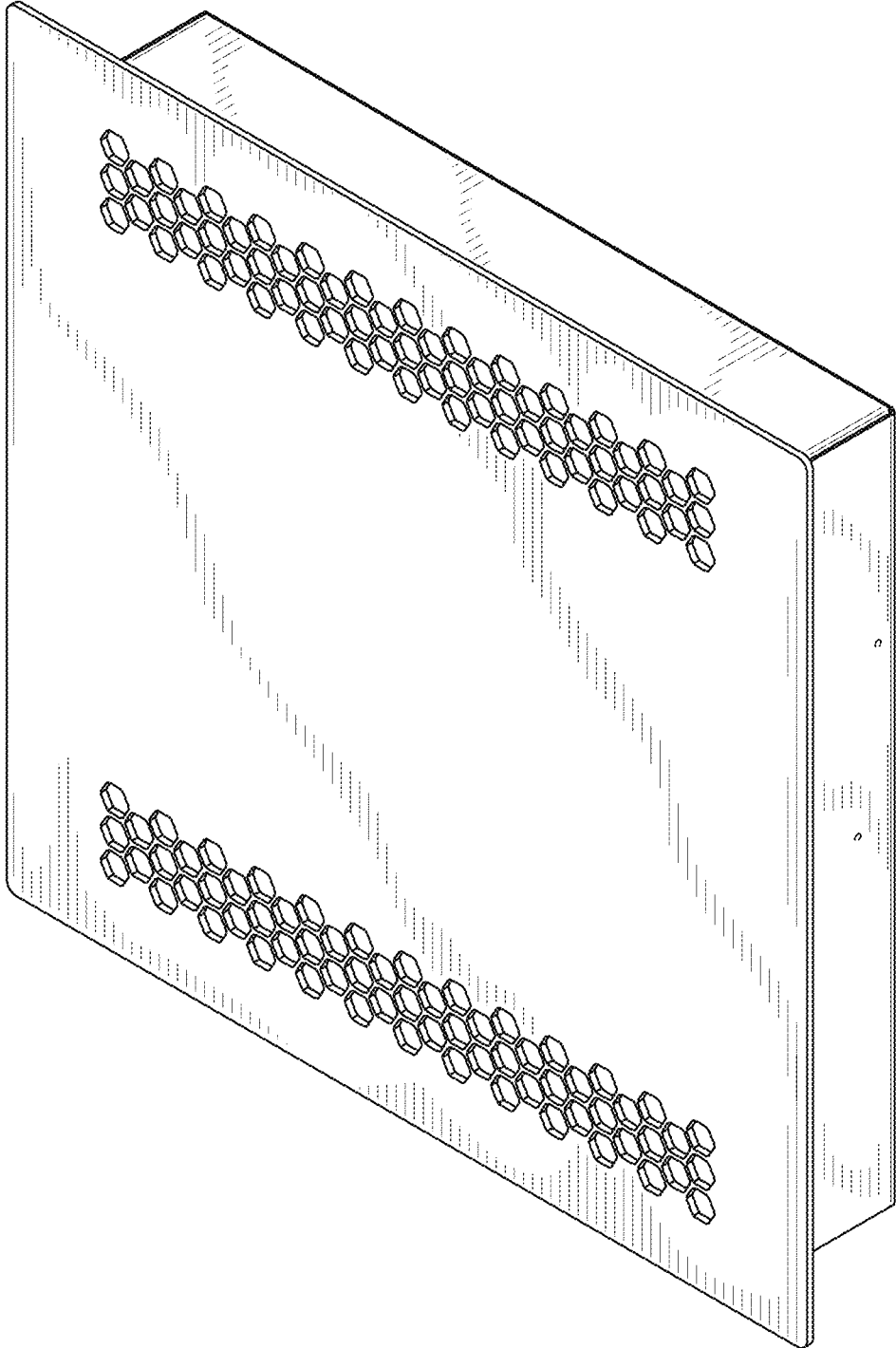

FIG. 1

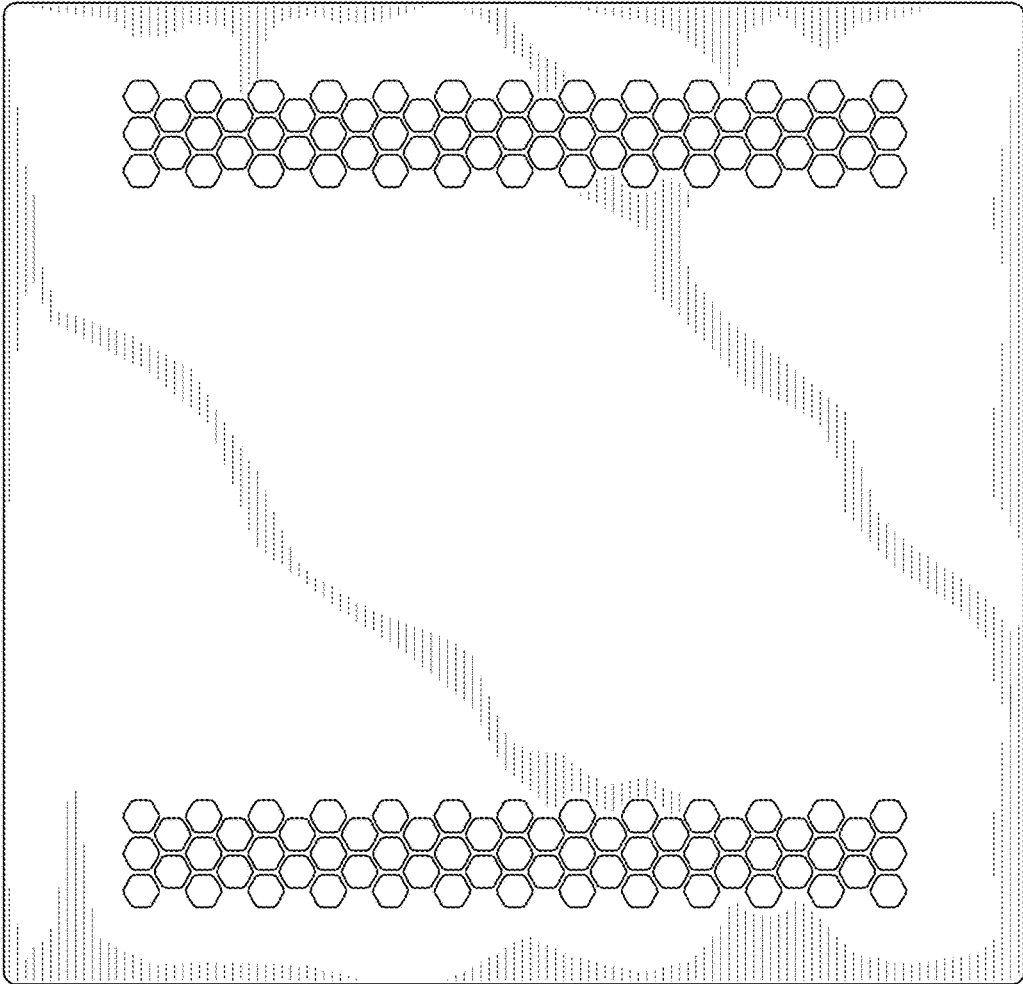

FIG. 2

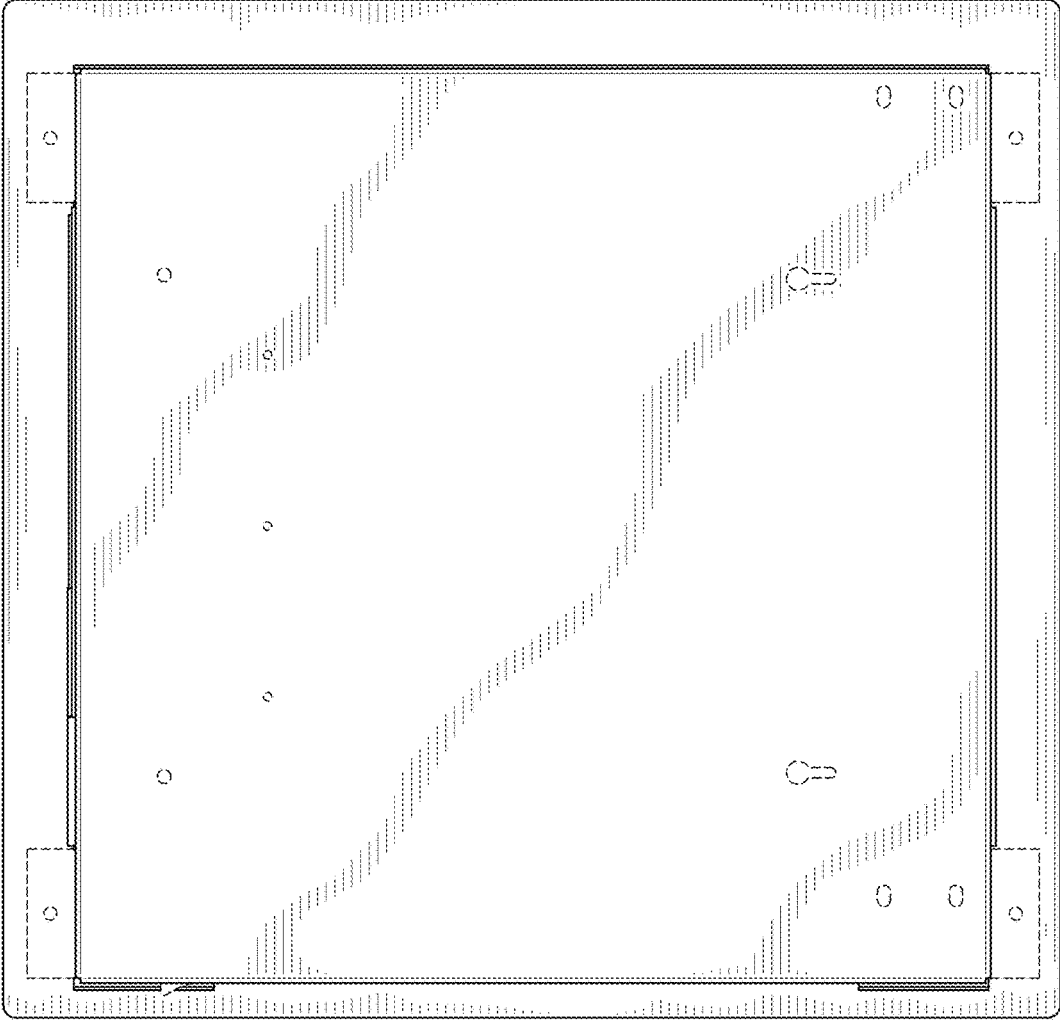

FIG. 3

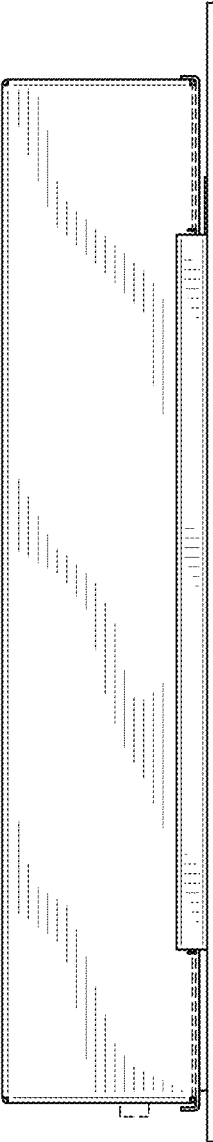

FIG. 4

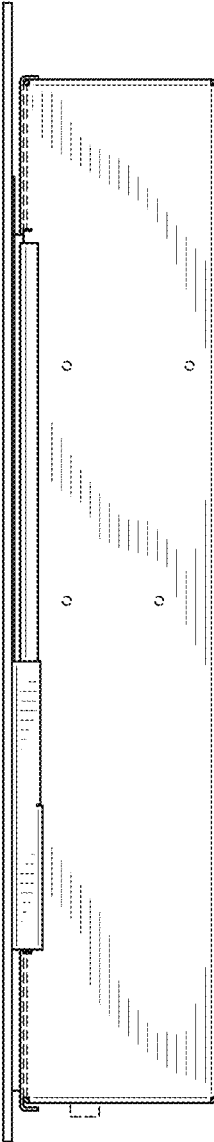

FIG. 5

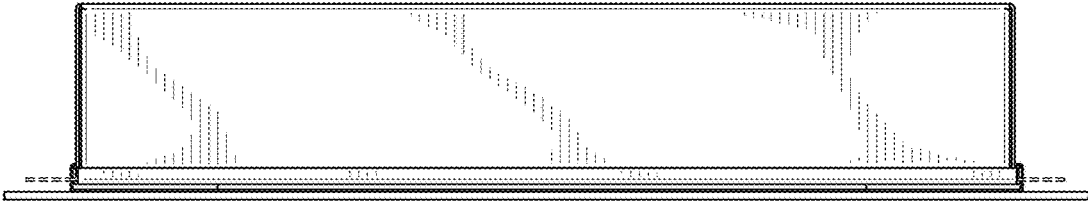

FIG. 6

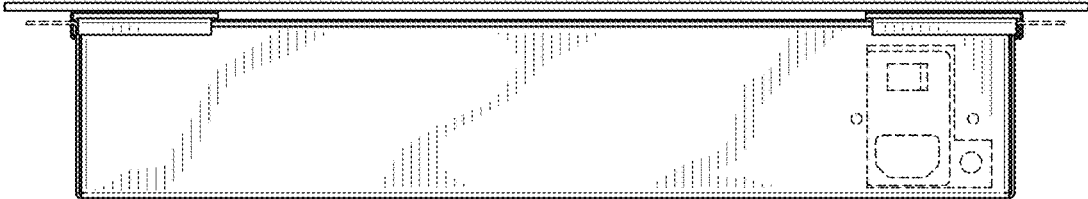

FIG. 7