

(19) World Intellectual Property Organization
International Bureau



(43) International Publication Date
7 June 2007 (07.06.2007)

PCT

(10) International Publication Number
WO 2007/064843 A1

(51) International Patent Classification:
C10M 161/00 (2006.01) *C10N 60/00* (2006.01)
C10N 30/10 (2006.01)

(74) Agents: PIERCE, N., Scott et al.; Hamilton, Brook, Smith & Reynolds, P.C., 530 Virginia Road, P.O. Box 9133, Concord, MA 01742-9133 (US).

(21) International Application Number:
PCT/US2006/045929

(81) Designated States (unless otherwise indicated, for every kind of national protection available): AE, AG, AL, AM, AT, AU, AZ, BA, BB, BG, BR, BW, BY, BZ, CA, CH, CN, CO, CR, CU, CZ, DE, DK, DM, DZ, EC, EE, EG, ES, FI, GB, GD, GE, GH, GM, GT, HN, HR, HU, ID, IL, IN, IS, JP, KE, KG, KM, KN, KP, KR, KZ, LA, LC, LK, LR, LS, LT, LU, LV, LY, MA, MD, MG, MK, MN, MW, MX, MY, MZ, NA, NG, NI, NO, NZ, OM, PG, PH, PL, PT, RO, RS, RU, SC, SD, SE, SG, SK, SL, SM, SV, SY, TJ, TM, TN, TR, TT, TZ, UA, UG, US, UZ, VC, VN, ZA, ZM, ZW.

(22) International Filing Date:
30 November 2006 (30.11.2006)

(25) Filing Language: English

(26) Publication Language: English

(30) Priority Data:
60/742,150 2 December 2005 (02.12.2005) US

(84) Designated States (unless otherwise indicated, for every kind of regional protection available): ARIPO (BW, GH, GM, KE, LS, MW, MZ, NA, SD, SL, SZ, TZ, UG, ZM, ZW), Eurasian (AM, AZ, BY, KG, KZ, MD, RU, TJ, TM), European (AT, BE, BG, CH, CY, CZ, DE, DK, EE, ES, FI, FR, GB, GR, HU, IE, IS, IT, LT, LU, LV, MC, NL, PL, PT, RO, SE, SI, SK, TR), OAPI (BF, BJ, CF, CG, CI, CM, GA, GN, GQ, GW, ML, MR, NE, SN, TD, TG).

(71) Applicant (for all designated States except US): POLNOX CORPORATION [US/US]; Four Cambridge Center, Second Floor, Cambridge, MA 02142 (US).

(72) Inventors; and

(75) Inventors/Applicants (for US only): CHOLLI, Ashok, L. [US/US]; 6 Rosemary Lane, Chelmsford, MA 01824 (US). DHAWAN, Ashish [IN/US]; 51 School Street, No. 16, Lowell, MA 01854 (US). KUMAR, Rajesh [IN/US]; 820 Skyline Drive, No. 16, Dracut, MA 01826 (US). KUMAR, Vijayendra [IN/US]; 710 Skyline Drive, No. 9, Dracut, MA 01826 (US). YANG, Suizhou [CN/US]; 61 East Longmeadow Lane, No. 5, Lowell, MA 01854 (US). CANTENWALA, Taizoon [IN/US]; 142 Riverside Street, No. 9, Lowell, MA 01854 (US).

Published:

- with international search report
- before the expiration of the time limit for amending the claims and to be republished in the event of receipt of amendments

For two-letter codes and other abbreviations, refer to the "Guidance Notes on Codes and Abbreviations" appearing at the beginning of each regular issue of the PCT Gazette.



WO 2007/064843 A1

(54) Title: LUBRICANT OIL COMPOSITIONS

(57) Abstract: Compositions comprise first antioxidants and first additives, such as, a surface additives, performance enhancing additives and lubricant protective additives and optionally second additives and/or second antioxidants. The compositions are useful to improve lubricants, lubricant oils and other lubricant materials. The compositions and methods generally provide longer shelf lives, increased oxidative resistance, improved quality and/or enhanced performance to lubricants or lubricant oils.

LUBRICANT OIL COMPOSITIONS

5 RELATED APPLICATION(S)

This application claims the benefit of U.S. Provisional Application No. 60/742,150, filed on December 2, 2005. The entire teachings of the above application(s) are incorporated herein by reference.

BACKGROUND OF THE INVENTION

10 Early lubrication began with animal fats and oils and slowly evolved to petroleum-based oils. Petroleum-based oil, however, do not perform as well as many of the animal-based products and require a lot of refining and treatment. Synthetic oils, which are made from small molecules, have historically had superior lubricating performance characteristics that could not be achieved with conventional
15 oils. However, while many lubricants currently exist, there is still a need for lubricants with improved properties.

SUMMARY OF THE INVENTION

The present invention relates to compositions comprising i) a first antioxidant and at least one first additive, selected from the group comprising
20 surface additives, performance enhancing additives and lubricant protective additives and optionally ii) a second additive and/or a second antioxidant (or stabilizer). These compositions are useful in the methods of the present invention to improve, for example, increase the shelf life, improve the quality and/or performance of lubricants, such as lubricant oils.

- 2 -

In one embodiment, the present invention is a composition comprising a first antioxidant, and at least one first additive selected from the group consisting of i) a surface additive; ii) a performance enhancing additive; and iii) a lubricant protective additive.

5 In another embodiments the present invention is a lubricant composition comprising: a lubricant or a mixture of lubricants, a first antioxidant and at least one first additive selected from the group consisting of i) a surface additive; ii) a performance enhancing additive; and iii) a lubricant protective additive.

10 In yet another embodiment the present invention is a method of improving a composition comprising combining the composition with a first antioxidant; and at least one first additive selected from the group consisting of i) a surface additive; ii) a performance enhancing additive; and iii) a lubricant protective additive.

15 In yet another embodiment the present invention is a method of improving a lubricant or a mixture of lubricants comprising combining the lubricant or mixture of lubricants with a first antioxidant; and at least one first additive selected from the group consisting of i) a surface additive; ii) a performance enhancing additive; and iii) a lubricant protective additive.

The compositions and methods of the present invention generally provide increased shelf life, increased oxidative resistance, enhanced performance and/or improved quality to materials, such as, for example, lubricants and lubricant oils. In general it is believed that because of the synergy of the antioxidants with the additives, the compositions described herein have superior oxidation resistance. The additives exhibit several key functions such as corrosion inhibition, detergency, viscosity modification, antiwear performance, dispersant properties, cleaning and suspending ability. The disclosed compositions, in general provide superior performance of lubricants in high temperatures applications due to the presence of antioxidants which are thermally stable at high temperatures with enhanced oxidation resistance.

30 DETAILED DESCRIPTION OF THE INVENTION

The present invention relates to compositions for improving lubricants, wherein the compositions comprise i) a first antioxidant selected from the group

- 3 -

comprising of antioxidants described in Provisional Patent Application No.s: 60/632,893, 60/633,197, 60/633,252, 60/633,196, 60/665,638, 60/655,169, 60/731,125, 60/731,021 and 60/731,325; US Patent Application No.s: 11/184,724, 11/184,716, 11/040,193, 10/761,933, 10/408,679 and 10/761,933; PCT Patent
 5 Application No.s: PCT/US2005/001948, PCT/US2005/001946 and PCT/US03/10782, the entire contents of each of which are incorporated herein by reference; along with at least one first additive selected from the groups comprising of surface additives, performance enhancing additives and lubricant protective additives; and optionally ii) a second additive and/or a second antioxidant (or
 10 stabilizer) wherein examples of suitable second additives and antioxidants are as described herein.

In one embodiment, the first antioxidants which are suitable for use in the compositions and methods of the present invention include, but are not limited to: polyalkyl phenol based antioxidants, sterically hindered phenol based antioxidants,
 15 sterically hindered phenol based macromolecular antioxidants, nitrogen and hindered phenol containing dual functional macromolecular antioxidants, alkylated macromolecular antioxidants, sterically hindered phenol and phosphite based macromolecular antioxidants.

In one embodiment, the first antioxidants which are suitable for use in the compositions and methods of the present invention include antioxidant polymers
 20 which comprises repeat units that include one or both of Structural Formulas (I) and (II):

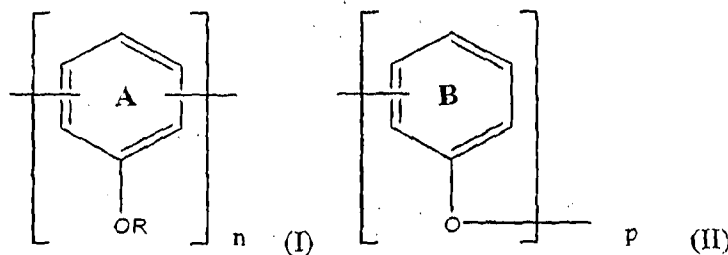

where:

25 R is -H or a substituted or unsubstituted alkyl, substituted or unsubstituted acyl or substituted or unsubstituted aryl group;

Ring A is substituted with at least one *tert*-butyl group or substituted or unsubstituted n-alkoxycarbonyl group, and optionally one or more groups selected

from the group consisting of -OH, -NH, -SH, a substituted or unsubstituted alkyl or aryl group, and a substituted or unsubstituted alkoxy carbonyl group;

Ring B is substituted with at least one -H and at least one *tert*-butyl group or substituted or unsubstituted n-alkoxy carbonyl group and optionally one or more groups selected from the group consisting of -OH, -NH, -SH, a substituted or unsubstituted alkyl or aryl group, and a substituted or unsubstituted alkoxy carbonyl group;

n is an integer equal to or greater than 2; and

p is an integer equal to or greater than 0.

In another embodiment, the first antioxidants which are suitable for use in the compositions and methods of the present invention include polymers with repeat units represented by one or both of Structural Formulas (III) and (IV):

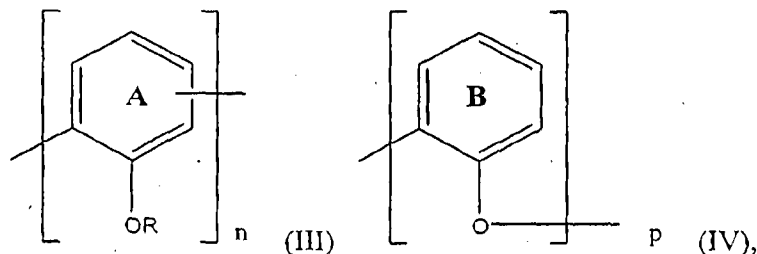

where Rings A and B are substituted as described above and n and p are as defined above.

Preferably, Ring A and Ring B in Structural Formulas (I) to (IV) are each substituted with at least one *tert*-butyl group.

In another embodiment, the first antioxidants which are suitable for use in the compositions and methods of the present invention include polymers with repeat units represented by one or more of Structural Formulas (Va), (Vb), (Vc), (VIa), (VIb) and (VIc):

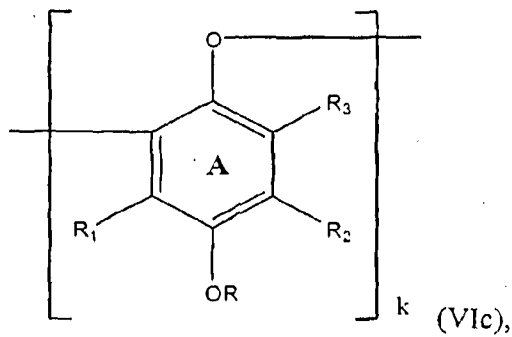
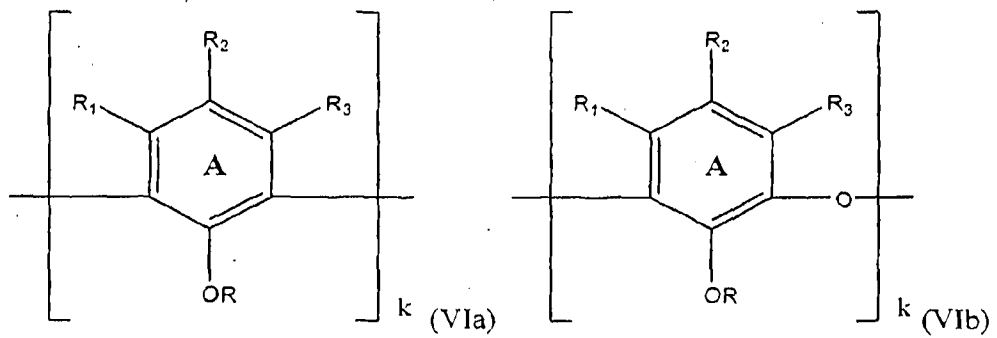
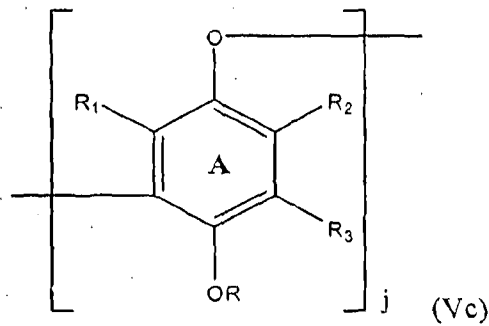
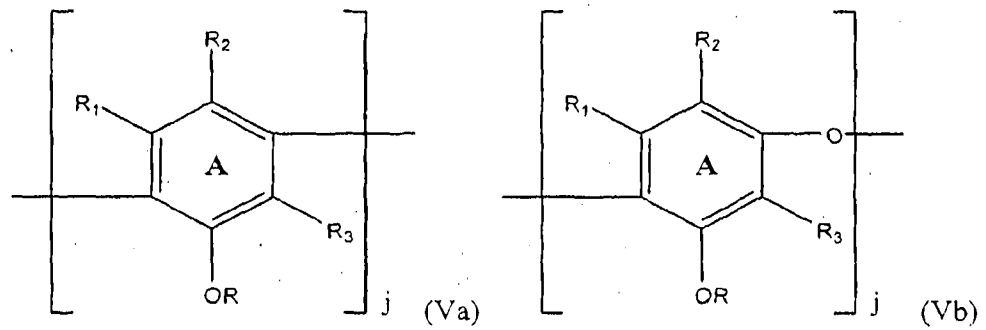

5 where R₁, R₂ and R₃ are independently selected from the group consisting of -H, -OH, -NH, -SH, a substituted or unsubstituted alkyl or a substituted or unsubstituted aryl group, and a substituted or unsubstituted alkoxy carbonyl group,

- 6 -

provided that at least one of R_1 , R_2 and R_3 is a tert-butyl group; and j and k are independently integers of zero or greater, such that the sum of j and k is equal to or greater than 2.

5 In a particular embodiment, R is $-H$ or $-CH_3$; R_2 is $-H$, $-OH$, or a substituted or unsubstituted alkyl group; or both.

Specific examples of repeat units included in polymers which are suitable for use in the compositions and methods of the present invention are represented by one of the following structural formulas:

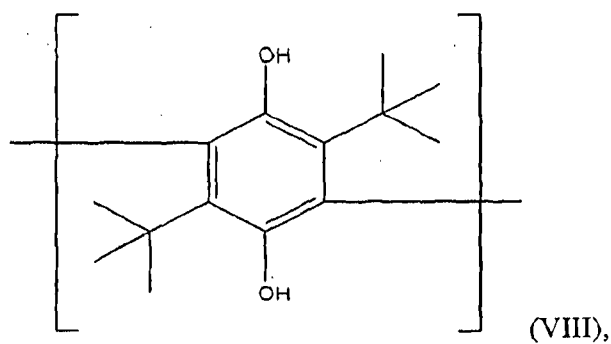
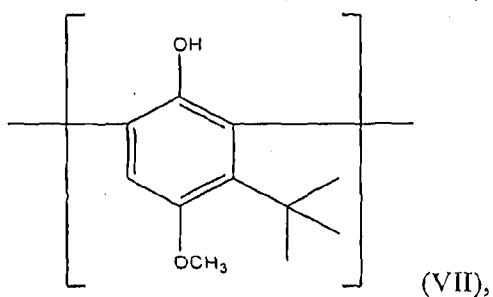

10

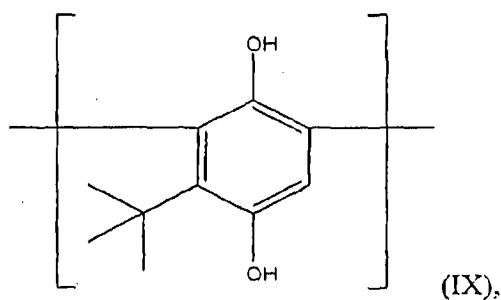

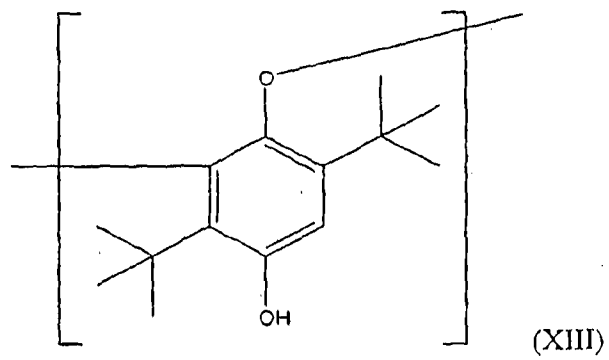
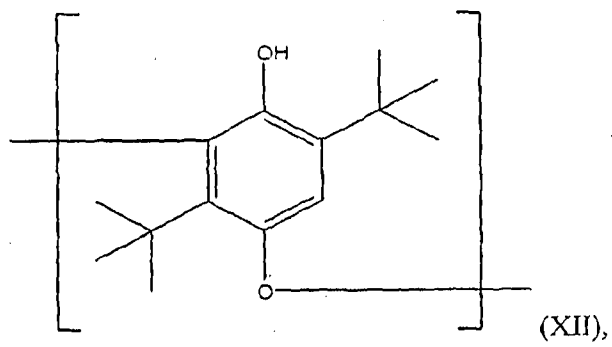
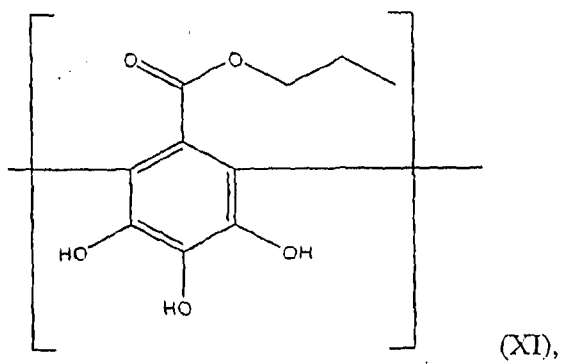
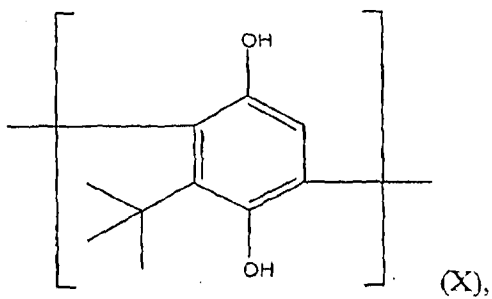

- 8 -

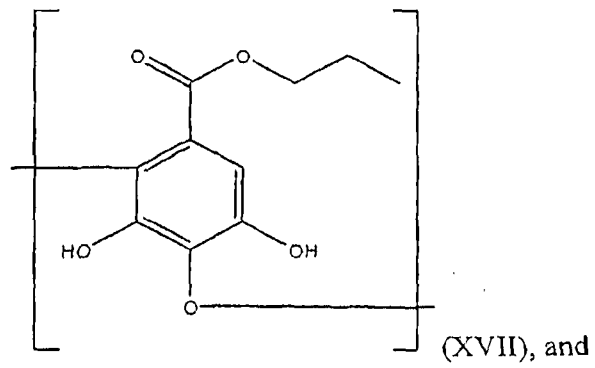
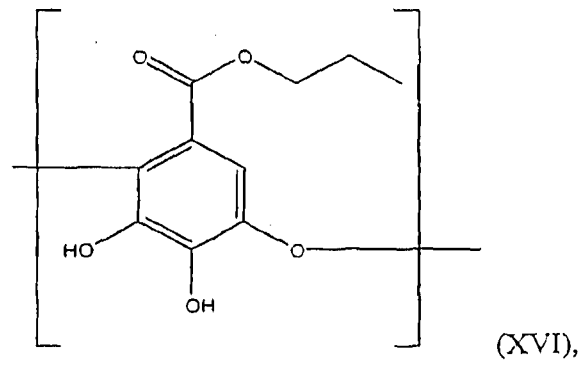
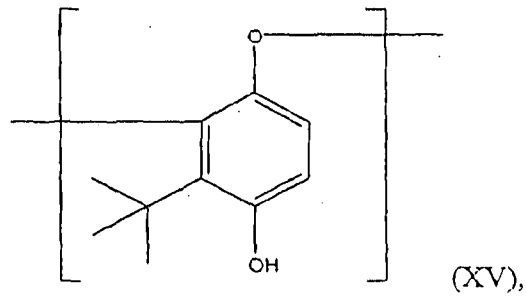
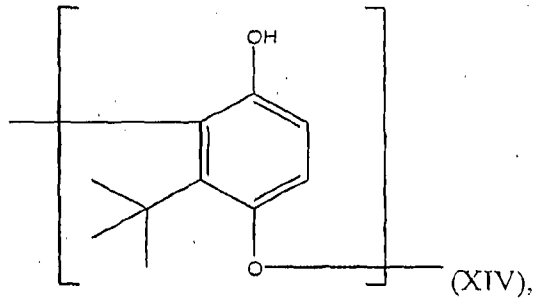

- 9 -

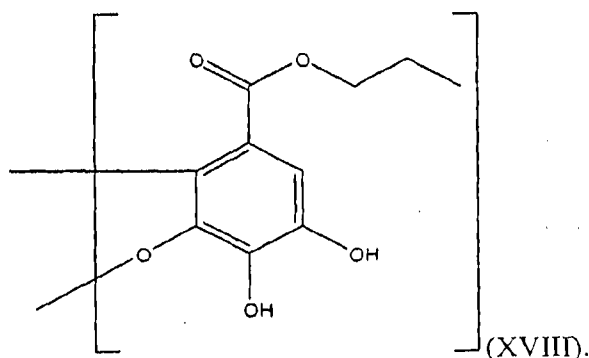

Antioxidant polymers as described immediately above which are suitable for use in the compositions and methods of the present invention have two or more repeat units, preferably greater than about five repeat units. The molecular weight of the polymers disclosed above is generally selected to be appropriate for the desired application. Typically, the molecular weight is greater than about 500 atomic mass units (amu) and less than about 2,000,000 amu, greater than about 1000 amu and less than about 100,000, greater than about 2,000 amu and less than about 10,000, or greater than about 2,000 amu and less than about 5,000 amu.

Antioxidant polymers as described immediately above which are suitable for use in the compositions and methods of the present invention can be either homopolymers or copolymers. A copolymer preferably contains two or more or three or more different repeating monomer units, each of which has varying or identical antioxidant properties. The identity of the repeat units in a copolymer can be chosen to modify the antioxidant properties of the polymer as a whole, thereby giving a polymer with tunable properties. The second, third and/or further repeat units in a copolymer can be either a synthetic or natural antioxidant.

Antioxidant polymers as described immediately above which are suitable for use in the compositions and methods of the present invention are typically insoluble in aqueous media. The solubility of the antioxidant polymers in non-aqueous media (e.g., oils) depends upon the molecular weight of the polymer, such that high molecular weight polymers are typically sparingly soluble in non-aqueous media. When an antioxidant polymer of the invention is insoluble in a particular medium or substrate, it is preferably well-mixed with that medium or substrate.

- 10 -

Antioxidant polymers as described immediately above which are suitable for use in the compositions and methods of the present invention can be branched or linear, but are preferably linear. Branched antioxidant polymers can only be formed from benzene molecules having three or fewer substituents (e.g., three or more
 5 hydrogen atoms), as in Structural Formulas (XX), (XXI) and (XXIV).

In another embodiment, the first antioxidants which are suitable for use in the compositions and methods of the present invention include polymers with repeat units represented by one or both of Structural Formulas (I) and (II):

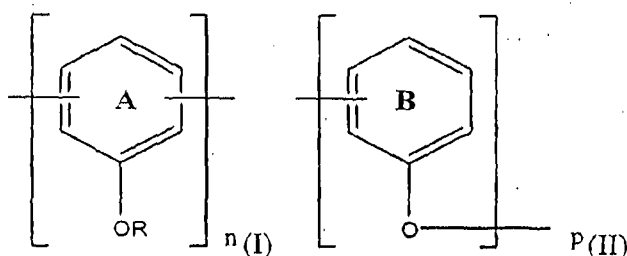

10 where:

R is -H or a substituted or unsubstituted alkyl, acyl or aryl group;

Ring A is substituted with at least one *tert*-butyl group, 1-ethenyl-2-carboxylic acid group or ester thereof, substituted or unsubstituted alkylenedioxy group, or substituted or unsubstituted *n*-alkoxycarbonyl group and zero, one or more
 15 additional functional groups;

Ring B is substituted with at least one -H and at least one *tert*-butyl group, 1-ethenyl-2-carboxylic acid group or ester thereof, substituted or unsubstituted alkylenedioxy group, or substituted or unsubstituted *n*-alkoxycarbonyl group and zero, one or more additional functional groups;

20 n is an integer equal to or greater than 2; and

p is an integer equal to or greater than 0,

where the polymer includes two or more repeat units represented by one or both of Structural Formulas (I) and (II) that are directly connected by a C-C or C-O-C bond between benzene rings.

25 Polymers as described immediately above which are suitable for use in the compositions and methods of the present invention that do not include any repeat units represented by Structural Formula (I) are preferably substituted on Ring B with one or more hydroxyl or acyloxy groups.

Repeat units of the antioxidant polymers as described immediately above which are suitable for use in the compositions and methods of the present invention include substituted benzene molecules. These benzene molecules are typically based on phenol or a phenol derivative, such that they have at least one hydroxyl, ester or ether functional group. Preferably, the benzene molecules have a hydroxyl group. The hydroxyl group is not restricted to being a free hydroxyl group, and the hydroxyl group can be protected or have a cleavable group attached to it (e.g., an ester group). Such cleavable groups can be released under certain conditions (e.g., changes in pH), with a desired shelf life or with a time-controlled release (e.g., measured by the half-life), which allows one to control where and/or when an antioxidant polymer is able to exert its antioxidant effect.

Substituted benzene repeat units of an antioxidant polymer as described immediately above which are suitable for use in the compositions and methods of the present invention are also typically substituted with a bulky alkyl group, a 1-ethenyl-2-carboxylic acid group, a substituted or unsubstituted alkylendioxy group, or an *n*-alkoxycarbonyl group. Preferably, the benzene monomers are substituted with a bulky alkyl group. More preferably, the bulky alkyl group is located *ortho* or *meta* to a hydroxyl group on the benzene ring. A "bulky alkyl group" is defined herein as an alkyl group that is branched *alpha*- or *beta*- to the benzene ring. Preferably, the alkyl group is branched *alpha* to the benzene ring. More preferably, the alkyl group is branched twice *alpha* to the benzene ring (i.e., to form an *alpha*-tertiary carbon), such as in a *tert*-butyl group. Other examples of bulky alkyl groups include isopropyl, 2-butyl, 3-pentyl, 1,1-dimethylpropyl, 1-ethyl-1-methylpropyl and 1,1-diethylpropyl. The bulky alkyl groups are preferably unsubstituted, but they can be substituted with a functional group that does not interfere with the antioxidant activity of the molecule or the polymer.

Substituted benzene repeat units that are substituted with a substituted or unsubstituted alkylendioxy group typically have an unsubstituted alkylendioxy group. Substituted alkylendioxy groups are also suitable, although the substituents should not interfere with the antioxidant activity of the molecule or the polymer. Typically, an alkylendioxy group is a lower alkylendioxy group, such as a

- 12 -

methylenedioxy group or an ethylenedioxy group. A methylenedioxy group is preferred (as in sesamol).

Straight chained alkoxy carbonyl groups typically have an alkyl chain of one to sixteen carbon atoms, and include methoxycarbonyl, ethoxycarbonyl, n-
5 propoxycarbonyl, n-butoxycarbonyl and n-pentoxycarbonyl. n-propoxycarbonyl is a preferred group. Similar to the bulky alkyl groups, n-alkoxy carbonyl groups are optionally substituted with a functional group that does not interfere with the antioxidant activity of the molecule or the polymer. Alkoxy carbonyl groups can also be present in their hydrolyzed form, namely as carboxy groups or carboxylic
10 acid groups.

In substituted benzene repeat units having a 1-ethenyl-2-carboxylic acid group or an ester thereof, the 1-carbon (i.e., the carbon distal from the carboxylic acid moiety) is attached to the benzene ring.

In addition to the substituents named above, substituted benzene repeat units
15 can have additional functional groups as substituents. For example, the additional functional groups can be selected from the group consisting of -OH, -NH, -SH, a substituted or unsubstituted alkyl or aryl group, a substituted or unsubstituted alkoxy carbonyl group, a substituted or unsubstituted alkoxy group and a saturated or unsaturated carboxylic acid group. Typically, the additional functional groups are
20 selected from the group consisting of -OH, a substituted or unsubstituted alkoxy group and a saturated or unsaturated carboxylic acid group.

Preferably, Ring A and Ring B in Structural Formulas (I) to (IV) are each substituted with at least one *tert*-butyl group.

Further, specific examples of repeat units included in polymers which are
25 suitable for use in the compositions and methods of the present invention are represented by one of the following structural formulas:

- 13 -

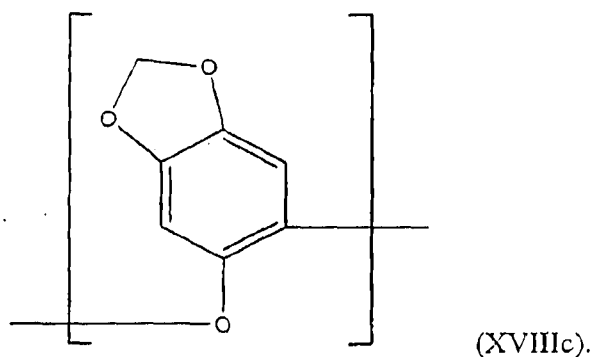
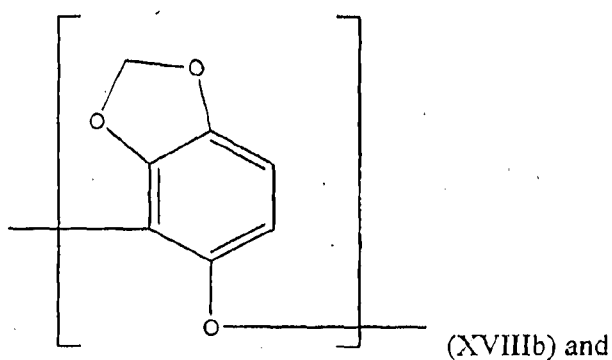
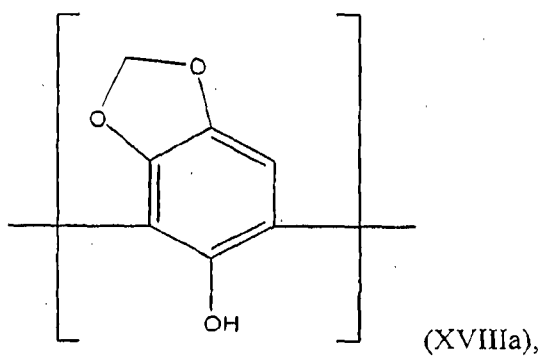

Although Structural Formulas (XI), (XVI), (XVII) and (XVIII) are
 5 represented as having a propoxycarbonyl substituent, this group can generally be
 replaced with a different C₁-C₁₆ n-alkoxycarbonyl group or can be a carboxylate
 group.

A particular polymer suitable for use in the methods and compositions of the
 present invention is poly(2-*tert*-butyl-4-hydroxyanisole).

- 14 -

Antioxidant polymers as described immediately above which are suitable for use in the methods and compositions of the present invention have two or more repeat units, preferably greater than about five repeat units. The molecular weight of the polymers disclosed herein is generally selected to be appropriate for the desired application. Typically, the molecular weight is greater than about 500 atomic mass units (amu) and less than about 2,000,000 amu, greater than about 1000 amu and less than about 100,000, greater than about 2,000 amu and less than about 10,000 amu, or greater than about 2,000 amu and less than about 5,000 amu.

Antioxidant polymers as described immediately above which are suitable for use in the methods and compositions of the present invention can be either homopolymers or copolymers. A copolymer preferably contains two or more or three or more different repeating monomer units, each of which has varying or identical antioxidant properties (including monomers having no antioxidant activity). The identity of the repeat units in a copolymer can be chosen to modify the antioxidant properties of the polymer as a whole, thereby giving a polymer with tunable properties. The second, third and/or further repeat units in a copolymer can be either a synthetic or natural antioxidant. In one example, a composition of the invention includes one or more homopolymers and one or more copolymers (e.g., in a blend). Preferably, both homopolymers and copolymers include two or more substituted benzene repeat units that are directly connected by a C-C or C-O-C bond. Preferably, at least 50%, such as at least 70%, for example, at least 80%, but preferably about 100% of the repeat units in a copolymer are substituted benzene repeat units directly connected by a C-C or C-O-C bond.

Examples of copolymers include poly(TBHQ-*co*-propyl gallate), poly(TBHQ-*co*-BHA), poly(TBHQ-*co*-sesamol), poly(BHA-*co*-sesamol), poly(propyl gallate-*co*-sesamol) and poly(BHA-*co*-propyl gallate). The ratio of one monomer to another, on a molar basis, is typically about 100:1 to about 1:100, such as about 10:1 to about 1:10, for example, about 2:1 to about 1:2. In one example, the ratio of monomers is about 1:1.

Antioxidant polymers as described immediately above which are suitable for use in the methods and compositions of the present invention are typically insoluble in aqueous media, although certain polymers of gallic acid and its esters are water

soluble. The solubility of the antioxidant polymers in non-aqueous media (e.g., oils) depends upon the molecular weight of the polymer, such that high molecular weight polymers are typically sparingly soluble in non-aqueous media. When an antioxidant polymer of the invention is insoluble in a particular medium or substrate,
 5 it is preferably well-mixed with that medium or substrate.

Antioxidant polymers as described immediately above which are suitable for use in the methods and compositions of the present invention can be branched or linear, but are preferably linear. Branched antioxidant polymers can only be formed from benzene molecules having three or fewer substituents (e.g., three or more
 10 hydrogen atoms), as in Structural Formulas (XX), (XXI) and (XXIV).

In another embodiment, the first antioxidants which are suitable for use in the compositions and methods of the present invention include a polyalkylphenol antioxidant represented by Structural Formula U or U'.

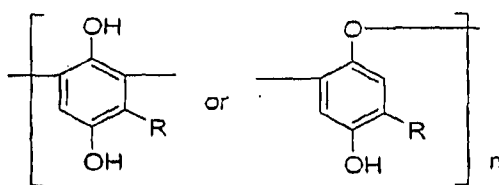

U

15

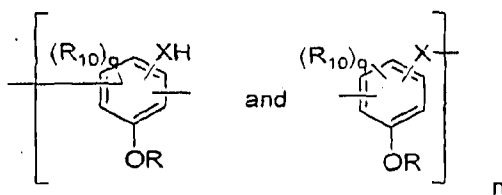

U'

In Structural Formula U or U', n is an integer equal or greater than 2. R is a
 20 C1-C10 alkyl group, an aryl group, or a benzyl group. Typically, R is a tertiary alkyl group, or in preferred embodiments, a tertiary butyl group. X is -O-, -NH- or -S-. Each R₁₀ is independently an optionally substituted C1-C10 alkyl group, an optionally substituted aryl group, and optionally substituted alkoxy group, an optionally substituted carbonyl group, an optionally substituted alkoxy carbonyl group, an optionally substituted aryloxy carbonyl group, -OH, -SH or -NH₂; or two

- 16 -

R₁₀ groups on adjacent carbon atoms join together to form an optionally substituted aromatic ring or an optionally substituted carbocyclic or heterocyclic non-aromatic ring. q is an integer from 0 to 2.

- 5 Repeat units of the antioxidant polymers as described immediately above which are suitable for use in the compositions and methods of the present invention include substituted benzene molecules. These benzene molecules are typically based on phenol or a phenol derivative, such that they have at least one hydroxyl or ether functional group. Preferably, the benzene molecules have a hydroxyl group.
- 10 The hydroxyl group can be a free hydroxyl group and can be protected or have a cleavable group attached to it (e.g., an ester group). Such cleavable groups can be released under certain conditions (e.g., changes in pH), with a desired shelf life or with a time-controlled release (e.g., measured by the half-life), which allows one to control where and/or when an antioxidant polymer can exert its antioxidant effect.
- 15 The repeat units can also include analogous thiophenol and aniline derivatives, e.g., where the phenol -OH can be replaced by -SH, -NH-, and the like.

Substituted benzene repeat units of an antioxidant polymer as described immediately above which are suitable for use in the compositions and methods of the present invention are also typically substituted with a bulky alkyl group or an

20 n-alkoxycarbonyl group. Preferably, the benzene monomers are substituted with a bulky alkyl group. More preferably, the bulky alkyl group is located *ortho* or *meta* to a hydroxyl group on the benzene ring, typically *ortho*. A "bulky alkyl group" is defined herein as an alkyl group that is branched *alpha*- or *beta*- to the benzene ring. Preferably, the alkyl group is branched alpha to the benzene ring. More preferably,

25 the alkyl group is branched twice alpha to the benzene ring, such as in a *tert*-butyl group. Other examples of bulky alkyl groups include isopropyl, 2-butyl, 3-pentyl, 1,1-dimethylpropyl, 1-ethyl-1-methylpropyl and 1,1-diethylpropyl. The bulky alkyl groups are preferably unsubstituted, but they can be substituted with a functional group that does not interfere with the antioxidant activity of the molecule or the

30 polymer. Straight chained alkoxy carbonyl groups include methoxycarbonyl, ethoxycarbonyl, n-propoxycarbonyl, n-butoxycarbonyl and n-pentoxycarbonyl. n-propoxycarbonyl is a preferred group. Similar to the bulky alkyl groups,

- 17 -

n-alkoxycarbonyl groups are optionally substituted with a functional group that does not interfere with the antioxidant activity of the molecule or the polymer.

In another embodiment, the first antioxidants which are suitable for use in the compositions and methods of the present invention include a polymer
 5 comprising repeat units represented by one or both of Structural Formulas (i) and (ii):

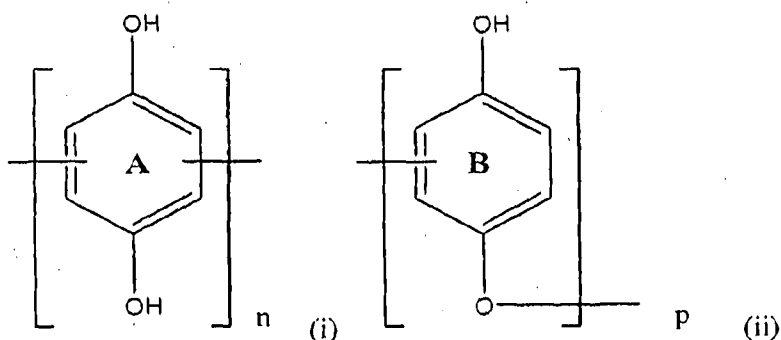

where:

Ring A is substituted with at least one *tert*-butyl group, and optionally one or
 10 more groups selected from the group consisting of a substituted or unsubstituted alkyl or aryl group, and a substituted or unsubstituted alkoxy carbonyl group;

Ring B is substituted with at least one -H and at least one *tert*-butyl group and optionally one or more groups selected from the group consisting of - a
 15 alkoxy carbonyl group;

n is an integer equal to or greater than 2; and

p is an integer equal to or greater than 0.

In another embodiment, the first antioxidants which are suitable for use in the compositions and methods of the present invention are polymers represented by
 20 one or both of Structural Formulas (iv) and (v):

- 18 -

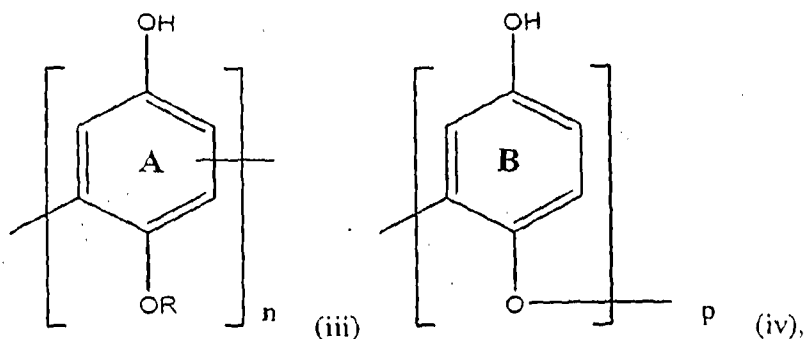

where Ring A is substituted with at least one *tert*-butyl group, and optionally one or more groups selected from the group consisting of a substituted or unsubstituted alkyl or aryl group, and a substituted or unsubstituted alkoxy carbonyl group; Ring B is substituted with at least one -H and at least one *tert*-butyl group and optionally one or more groups selected from the group consisting of a substituted or unsubstituted alkyl or aryl group, and a substituted or unsubstituted alkoxy carbonyl group; R is -H, an optionally substituted C1-C10 alkyl group, an aryl group, a benzyl group, or an acyl group n is an integer equal to or greater than 2; and p is an integer equal to or greater than 0. In one embodiment R is a C1-10 branched or linear alkyl group.

Antioxidant polymers as described immediately above which are suitable for use in the methods of the present invention have two or more repeat units, preferably greater than about five repeat units. The molecular weight of the polymers disclosed herein can be generally selected to be appropriate for the desired application. Typically, the molecular weight can be greater than about 500 atomic mass units (amu) and less than about 2,000,000 amu, greater than about 1,000 amu and less than about 100,000, greater than about 2,000 amu and less than about 10,000, or greater than about 2,000 amu and less than about 5,000 amu.

Antioxidant polymers as described immediately above which are suitable for use in the methods of the present invention can be either homopolymers or copolymers. A copolymer preferably contains two or more or three or more different repeating monomer units, each of which has varying or identical antioxidant properties. The identity of the repeat units in a copolymer can be chosen to modify the antioxidant properties of the polymer as a whole, thereby giving a

polymer with tunable properties. The second, third and/or further repeat units in a copolymer can be either a synthetic or natural antioxidant.

Antioxidant polymers as described immediately above which are suitable for use in the methods of the present invention are typically insoluble in aqueous media.

5 The solubility of the antioxidant polymers in non-aqueous media (e.g., oils) depends upon the molecular weight of the polymer, such that high molecular weight polymers are typically sparingly soluble in non-aqueous media. When an antioxidant polymer of the invention can be insoluble in a particular medium or substrate, it can be preferably well-mixed with that medium or substrate.

10 Antioxidant polymers as described immediately above which are suitable for use in the methods of the present invention can be branched or linear, but are preferably linear. Branched antioxidant polymers can only be formed from benzene molecules having three or fewer substituents (e.g., three or more hydrogen atoms), as in Structural Formulas (XX), (XXI) and (XXIV).

15 Another specific example of a repeat unit included in polymers which are suitable for use in the compositions and methods of the present invention is represented by the following structural formula:

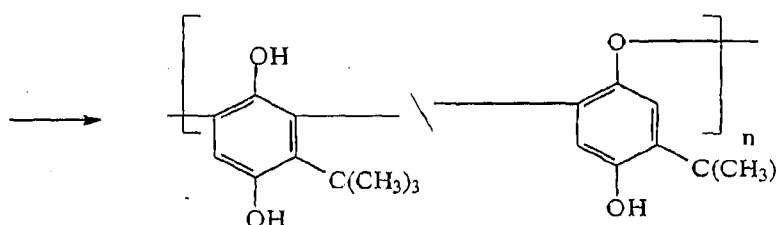

In another embodiment, the first antioxidant polymers which are suitable for use in the compositions and methods of the present invention includes a

20 macromolecule which can be represented by one or both of Structural Formulas R and S:

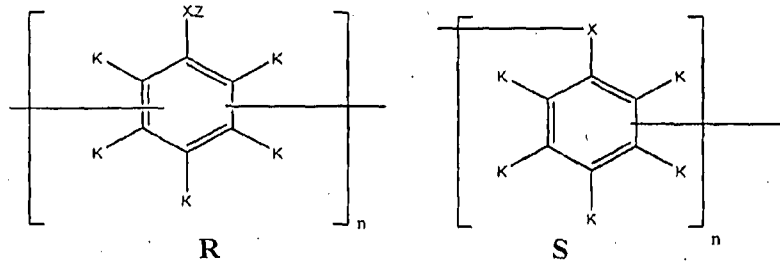

In Structural Formulas **R** and **S**, n is an integer equal to or greater than 2.

The variable X is O, NH, or S.

5 The variable Z is H.

Each variable K is independently $-H$ or $-OH$, with at least one $-OH$ adjacent to a $-H$; or K is a bond when that position is involved in the polymer chain.

In another embodiment, the first antioxidants which are suitable for use in the compositions and methods of the present invention includes a macromolecular antioxidant polymer represented by one or both of Structural Formulas **T** and **V** or **T'** and **V'**:

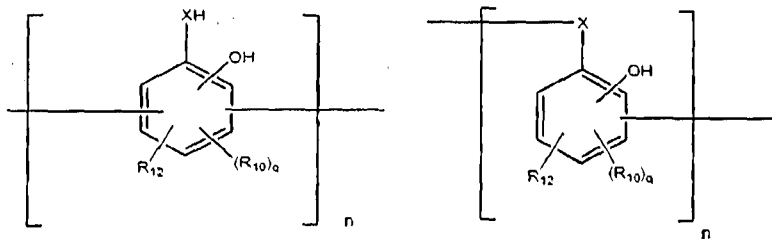
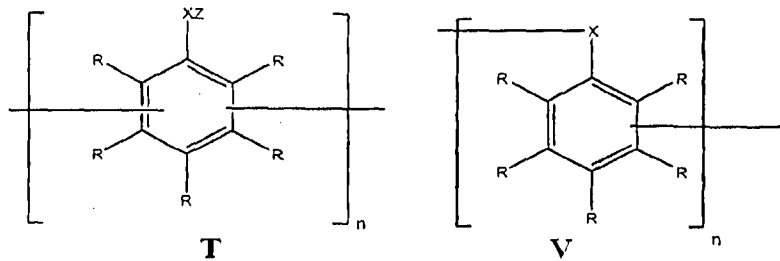

15

In Structural Formulas **T**, **T'**, **V** and **V'**, n is an integer equal to or greater than 2.

- 21 -

The variable X is O, NH, or S.

The variable Z is H.

Each variable R is independently -H, -OH, a C1-C10 alkyl group, or a bond when that position is involved in the polymer chain wherein at least one -OH is adjacent to a C1-C10 alkyl group, e.g., a tertiary butyl group.

Each R₁₀ is independently an optionally substituted C1-C10 alkyl group, an optionally substituted aryl group, and optionally substituted alkoxy group, an optionally substituted carbonyl group, an optionally substituted alkoxy carbonyl group, an optionally substituted aryloxy carbonyl group, -OH, -SH or -NH₂ or two R₁₀ groups on adjacent carbon atoms join together to form an optionally substituted aromatic ring or an optionally substituted carbocyclic or heterocyclic non-aromatic ring. q is an integer from 0 to 2. R₁₂ is a bulky alkyl group substituent bonded to a ring carbon atom adjacent (*ortho*) to a ring carbon atom substituted with an -OH group.

n is an integer equal to or greater than 2.

These macromolecular antioxidant polymers can contain, for example, tert-butylhydroquinone, 2, 5-di-tert-butylhydroquinone, BHT type repeat units and their combinations. In some embodiments, of the macromolecular antioxidants described immediately above can be homopolymers, copolymers, terpolymers, and the like

Substituted benzene repeat units of an antioxidant polymer as described immediately above which are suitable for use in the methods and compositions of the present invention are typically substituted with a bulky alkyl group or an n-alkoxy carbonyl group. Preferably, the benzene monomers are substituted with a bulky alkyl group. More preferably, the bulky alkyl group is located *ortho* or *meta* to a hydroxyl group on the benzene ring, typically *ortho*. A "bulky alkyl group" is defined herein as an alkyl group that is branched *alpha*- or *beta*- to the benzene ring. Preferably, the alkyl group is branched *alpha* to the benzene ring. More preferably, the alkyl group is branched twice *alpha* to the benzene ring, such as in a *tert*-butyl group. Other examples of bulky alkyl groups include isopropyl, 2-butyl, 3-pentyl, 1,1-dimethylpropyl, 1-ethyl-1-methylpropyl and 1,1-diethylpropyl. The bulky alkyl groups are preferably unsubstituted, but they can be substituted with a functional

group that does not interfere with the antioxidant activity of the molecule or the polymer. Straight chained alkoxy carbonyl groups include methoxycarbonyl, ethoxycarbonyl, n-propoxycarbonyl, n-butoxycarbonyl and n-pentoxycarbonyl. n-propoxycarbonyl is a preferred group. Similar to the bulky alkyl groups, n-alkoxycarbonyl groups are optionally substituted with a functional group that does not interfere with the antioxidant activity of the molecule or the polymer.

Antioxidant polymers as described immediately above which are suitable for use in the methods and compositions of the present invention have two or more repeat units, preferably greater than about five repeat units. The molecular weight of the polymers disclosed herein can be generally selected to be appropriate for the desired application. Typically, the molecular weight can be greater than about 500 atomic mass units (amu) and less than about 2,000,000 amu, greater than about 1,000 amu and less than about 100,000, greater than about 2,000 amu and less than about 10,000, or greater than about 2,000 amu and less than about 5,000 amu.

Antioxidant polymers as described immediately above which are suitable for use in the methods and compositions of the present invention can be either homopolymers or copolymers. A copolymer preferably contains two or more or three or more different repeating monomer units, each of which has varying or identical antioxidant properties. The identity of the repeat units in a copolymer can be chosen to modify the antioxidant properties of the polymer as a whole, thereby giving a polymer with tunable properties. The second, third and/or further repeat units in a copolymer can be either a synthetic or natural antioxidant.

Antioxidant polymers as described immediately above which are suitable for use in the methods and compositions of the present invention are typically insoluble in aqueous media. The solubility of the antioxidant polymers in non-aqueous media (e.g., oils) depends upon the molecular weight of the polymer, such that high molecular weight polymers are typically sparingly soluble in non-aqueous media. When an antioxidant polymer of the invention can be insoluble in a particular medium or substrate, it can be preferably well-mixed with that medium or substrate.

Antioxidant polymers as described immediately above which are suitable for use in the methods and compositions of the present invention can be branched or linear, but are preferably linear. Branched antioxidant polymers can only be formed

from benzene molecules having three or fewer substituents (e.g., three or more hydrogen atoms), as in Structural Formulas (XX), (XXI) and (XXIV).

Specific examples of repeat units included in polymers which are suitable for use in the compositions and methods of the present invention are represented by one of the following structural formulas:

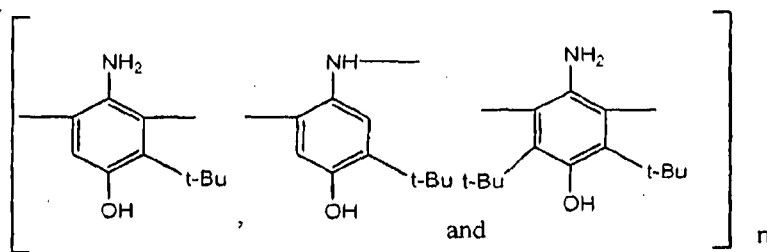
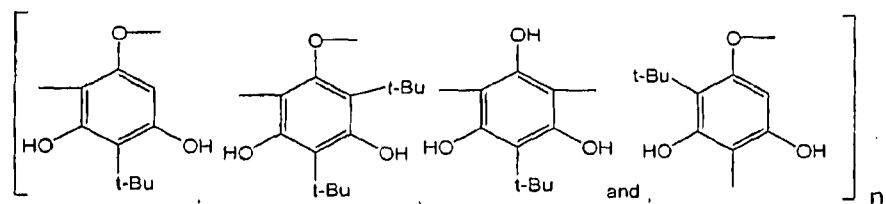
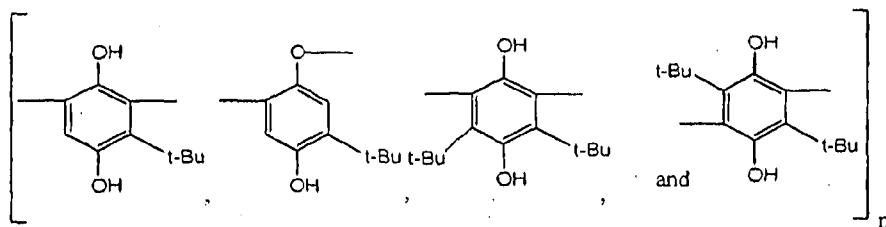
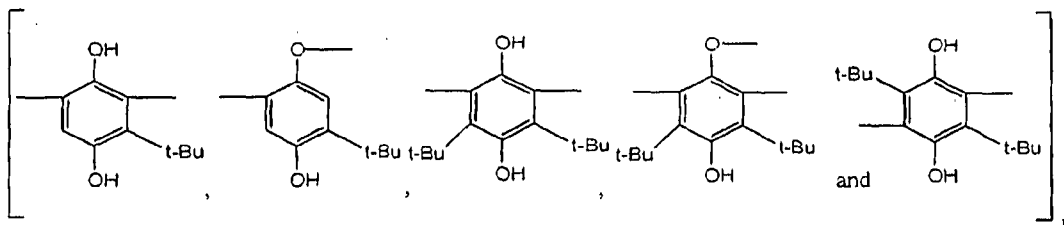

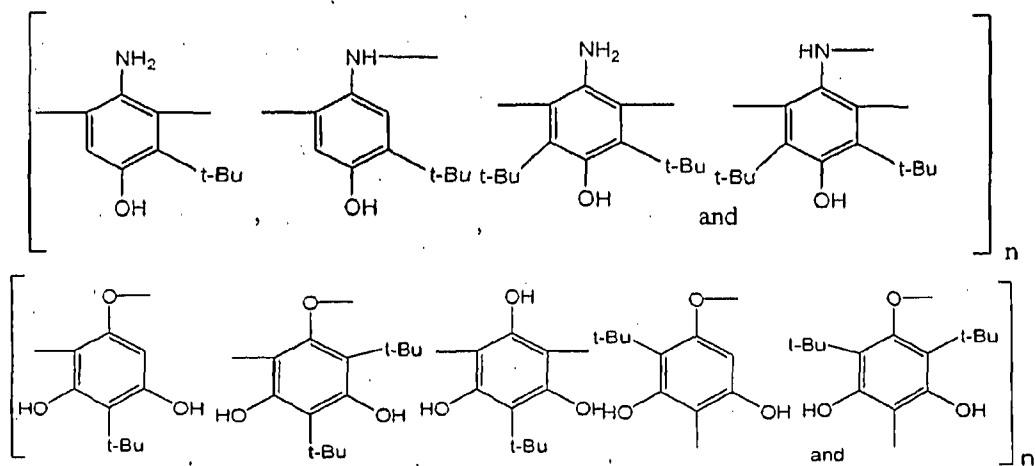

5

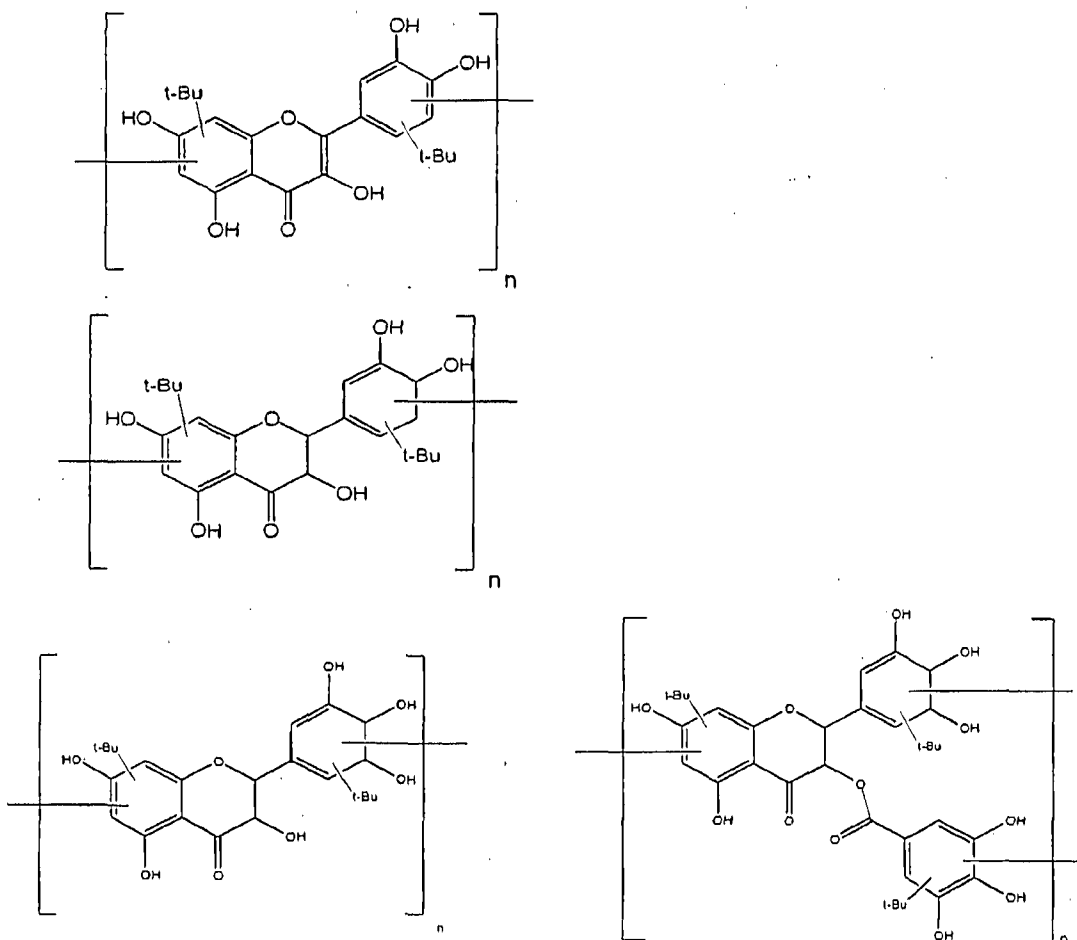

- 26 -

In structural formula M' each X is independently -O-, -NH- or -S-. Each R₁₀ is independently an optionally substituted C1-C10 alkyl group, an optionally substituted aryl group, and optionally substituted alkoxy group, an optionally substituted carbonyl group, an optionally substituted alkoxy carbonyl group, an optionally substituted aryloxy carbonyl group, -OH, -SH or -NH₂; and/or two R₁₀ groups on adjacent carbon atoms join together to form an optionally substituted aromatic ring or an optionally substituted carbocyclic or heterocyclic non-aromatic ring. q is an integer from 0 to 2. n is an integer greater than or equal to 2.

Substituted benzene repeat units of an antioxidant polymer as described immediately above which are suitable for use in the methods and compositions of the present invention are also typically substituted with a bulky alkyl group or an n-alkoxy carbonyl group. Preferably, the benzene monomers are substituted with a bulky alkyl group. More preferably, the bulky alkyl group is located *ortho* or *meta* to a hydroxyl group on the benzene ring, typically *ortho*. A "bulky alkyl group" is defined herein as an alkyl group that is branched *alpha*- or *beta*- to the benzene ring. Preferably, the alkyl group is branched *alpha* to the benzene ring. More preferably, the alkyl group is branched twice *alpha* to the benzene ring, such as in a *tert*-butyl group. Other examples of bulky alkyl groups include isopropyl, 2-butyl, 3-pentyl, 1,1-dimethylpropyl, 1-ethyl-1-methylpropyl and 1,1-diethylpropyl. The bulky alkyl groups are preferably unsubstituted, but they can be substituted with a functional group that does not interfere with the antioxidant activity of the molecule or the polymer. Straight chained alkoxy carbonyl groups include methoxy carbonyl, ethoxy carbonyl, n-propoxy carbonyl, n-butoxy carbonyl and n-pentoxy carbonyl. n-propoxy carbonyl is a preferred group. Similar to the bulky alkyl groups, n-alkoxy carbonyl groups are optionally substituted with a functional group that does not interfere with the antioxidant activity of the molecule or the polymer.

Antioxidant polymers as described immediately above which are suitable for use in the methods and compositions of the present invention have two or more repeat units, preferably greater than about five repeat units. The molecular weight of the polymers disclosed herein can be generally selected to be appropriate for the desired application. Typically, the molecular weight can be greater than about 500 atomic mass units (amu) and less than about 2,000,000 amu, greater than about

- 27 -

1,000 amu and less than about 100,000, greater than about 2,000 amu and less than about 10,000, or greater than about 2,000 amu and less than about 5,000 amu.

Antioxidant polymers as described immediately above which are suitable for use in the methods and compositions of the present invention can be either
5 homopolymers or copolymers. A copolymer preferably contains two or more or three or more different repeating monomer units, each of which has varying or identical antioxidant properties. The identity of the repeat units in a copolymer can be chosen to modify the antioxidant properties of the polymer as a whole, thereby giving a polymer with tunable properties. The second, third and/or further repeat
10 units in a copolymer can be either a synthetic or natural antioxidant.

Antioxidant polymers as described immediately above which are suitable for use in the methods and compositions of the present invention are typically insoluble in aqueous media. The solubility of the antioxidant polymers in non-aqueous media (e.g., oils) depends upon the molecular weight of the polymer, such that high
15 molecular weight polymers are typically sparingly soluble in non-aqueous media. When an antioxidant polymer of the invention can be insoluble in a particular medium or substrate, it can be preferably well-mixed with that medium or substrate.

Antioxidant polymers as described immediately above which are suitable for use in the methods and compositions of the present invention can be branched or
20 linear, but are preferably linear. Branched antioxidant polymers can only be formed from benzene molecules having three or fewer substituents (e.g., three or more hydrogen atoms), as in Structural Formulas (XX), (XXI) and (XXIV).

In another embodiment, the first antioxidants which are suitable for use in the compositions and methods of the present invention include a polymer having at
25 least one repeat unit that is represented by a structure selected from the group consisting of Structural Formulas (A), (B), (C), (D) and combinations thereof:

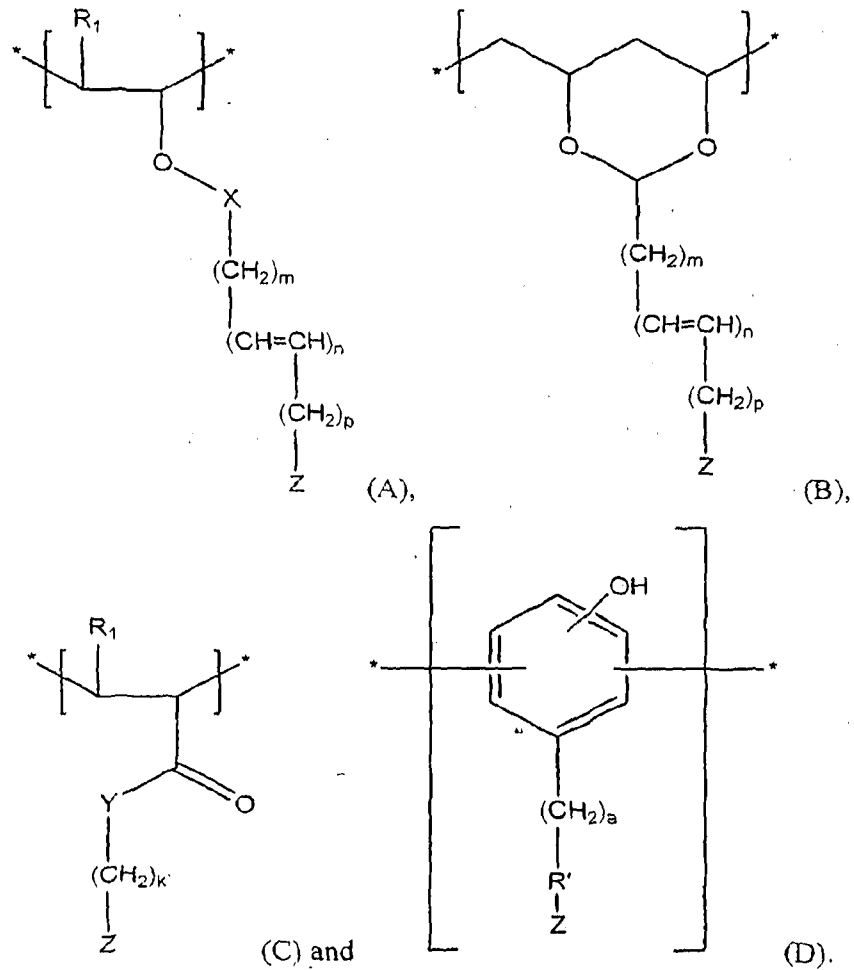

- 5 R' is a covalent bond, -O-, -C(O)O-, -C(O)N-, -C(O)-, -CH=CH-, -S- or -N-.
- R₁ is -H or an alkyl group, or -(CH₂)_k-O-X-Z. Typically, R₁ is -H or alkyl.
- Each X is independently a covalent bond, -C(O)-, -C(O)O- or -C(O)N-.
- Y is -O-, -N- or -S-.
- Each Z is an independently selected antioxidant.
- a is an integer from 0 to 12.
- Each k is independently an integer from 0 to 12.
- 10 m is an integer from 0 to 6.
- n is 0 or 1.
- p is an integer from 0 to 6.
- In one embodiment, the polymer does not include cyclic anhydride repeat units.

- 29 -

An antioxidant can be attached to the polymer by one or more linkages or bonds. Examples of suitable linkages include acetal, amide, amine, carbamate, carbonate, ester, ether and thioether linkage. Carbon-carbon bonds can be also suitable. As used herein, an amide is distinguished from a diacyl hydrazide.

5 There are many examples of polymers that can be derivatized with an antioxidant. One type of such polymer has pendant hydroxyl groups, such as poly(vinyl alcohol) and copolymers thereof (e.g., poly(ethylene-*co*-vinyl alcohol)). The hydroxyl groups of poly(vinyl alcohol), a polyhydroxyalkyl methacrylate (e.g., polyhydroxy methyl methacrylate), and poly(ethylene-*co*-vinyl alcohol) react with
 10 an antioxidant to form the derivatized antioxidant polymer. Another type of derivatizable polymer contains pendant carboxylic acid groups or esters thereof, such as poly(acrylic acid), poly(alkylacrylic acid) and esters thereof. Poly(acrylic acid) is a preferred polymer; the carboxylic acid groups of poly(acrylic acid) can be derivatized, although carboxylic acid groups generally require activation before
 15 derivatization can occur.

An additional type of derivatizable polymer can be a poly(substituted phenol), where the substituted phenol has a substituent with a nucleophilic or electrophilic moiety. Such poly(substituted phenols) can include repeat units represented by the following structural formulas:

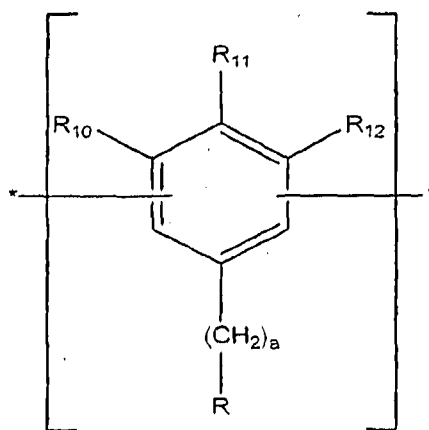

20

where *a* is an integer from 0 to 12; R is -OH, -COOH, -NH₂, -SH or a halogen; and R₁₀, R₁₁ and R₁₂ are each independently -H, -OH, -NH₂ or -SH, provided that at least one of R₁₀, R₁₁ and R₁₂ is -OH, -NH₂ or -SH. Preferably, one of R₁₀, R₁₁ and

- 30 -

R₁₂ is -OH and the remaining two are optionally -H. More preferably, R₁₁ is -OH and R₁₀ and R₁₂ are -H.

The derivatizable polymers can be homopolymers or copolymers.

Copolymers include, for example, block, star, hyperbranched, random, gradient
5 block, and alternate copolymers. The derivatizable polymers can be branched or linear, but are preferably linear.

In copolymers, it is only necessary for one repeat unit to include a pendant reactive group. Second and further repeat units of a copolymer can optionally include a pendant reactive group. For example, about 1% to 100%, such as 10% to
10 50% or 50% to 100%, of the repeat units of a polymer include pendant functional groups.

All or a fraction of the pendant reactive groups of a derivatizable polymer can be derivatized with an antioxidant. In one example, about 100% of the pendant reactive groups can be derivatized. In another example, about 5% to about 90%,
15 such as about 20% to about 80% (e.g., about 50% to about 80%) of the pendant reactive groups can be derivatized.

These polymers can be minimally derivatized with a single type of antioxidant, but can be derivatized with two or more antioxidants (e.g., chemically distinct antioxidants). When there can be two or more antioxidants, they can be in
20 the same class, as described below, or can be in different classes. The ratio of antioxidants can be varied in order to obtain a polymer having a desired set of properties. For example, when a polymer can be derivatized with two antioxidants, the ratio of a first antioxidant to a second antioxidant can be from about 20:1 to about 1:20, such as from about 5:1 to about 1:5 (e.g., about 1:1).

25 Many antioxidants can be suitable, provided that they can be attached to a polymer and retain their antioxidant activity. One class of suitable antioxidants can be phenolic antioxidants. Phenolic antioxidants typically have one or more bulky alkyl groups (alkyl groups having a secondary or tertiary carbon alpha to the phenol ring) *ortho* or *meta*, preferably *ortho*, to the phenol hydroxyl group. Phenolic
30 antioxidants can alternatively have an alkylendioxy substituent, an alkoxy carbonyl substituent, a 1-propenyl-3-carboxylic acid substituent or an ester thereof. A preferred bulky alkyl group is a *tert*-butyl group. The phenol hydroxyl group can be

- 31 -

protected by a removable protecting group (e.g., an acyl group). Phenolic antioxidants for use in the present invention also generally have a substituent that can react with the pendant reactive group of one of the polymers described above to form a covalent bond between the antioxidant and the polymer.

5 One group of suitable phenolic antioxidants can be represented by Structural Formula (E):

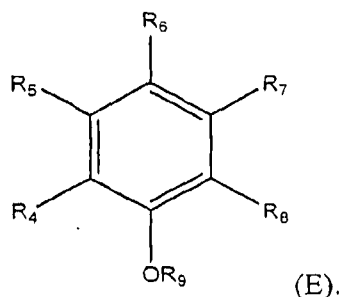

R_9 is $-H$ or a substituted or unsubstituted alkyl, acyl or aryl group, preferably $-H$ or an acyl group.

10 R_4 , R_5 , R_6 , R_7 and R_8 are independently chosen substituent groups, such that at least one substituent can be a substituted or unsubstituted alkyl or aryl group, a substituted or unsubstituted alkoxy carbonyl group, a substituted or unsubstituted alkylenedioxy group, a 1-propenyl-3-carboxylic acid group or an ester thereof. Also, at least one of R_4 , R_5 , R_6 , R_7 and R_8 must be a substituent capable of reacting
15 with the pendant reactive group of the polymers described above, such as a substituent having a nucleophilic or electrophilic moiety. Other suitable substituents include, for example, $-H$, $-OH$, $-NH$ and $-SH$. A substituent should not decrease the antioxidant activity more than two-fold; instead, substituents preferably increase the antioxidant activity of the molecule.

20 Specific examples of phenolic antioxidants that can be attached to a polymer include phenolic antioxidant can be selected from the group consisting of
3-(3,5-di-*tert*-butyl-4-hydroxyphenyl) propionic acid,
3,5-di-*tert*-butyl-4-hydroxybenzenethiol,
2-(3,5-di-*tert*-butyl-4-hydroxyphenyl)acetic acid, 3,5-di-*tert*-butyl-4-hydroxybenzoic
25 acid, 3,5-di-*tert*-butyl-4-hydroxycinnamic acid, gallic acid, alkyl gallates,
3,5-di-*tert*-butyl-4-hydroxybenzyl alcohol, *tert*-butyl-hydroquinone,

- 32 -

2,5-di-*tert*-butyl-hydroquinone, 2,6-di-*tert*-butyl-hydroquinone,
3,5-di-*tert*-butyl-4-hydroxybenzaldehyde, monoacetoxy-*tert*-butylhydroquinone,
sesamol, isoflavones, flavanoids and coumarins.

Another antioxidant that can be attached to one of the polymers described
5 immediately above can be ascorbic acid or a molecule that contains an ascorbic acid
moiety. Typically, ascorbic acid attached to a polymer has the following
configuration:

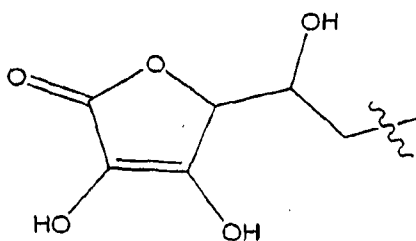

where this moiety can be attached to the polymer by an ether or ester linkage.

10 Polymers described immediately above which are suitable for use in the
compositions and methods of the present invention can be homopolymers or
copolymers. One type of copolymer includes ethylene repeat units, particularly in a
copolymer containing repeat units represented by Structural Formula (A) and/or
Structural Formula (B).

15 In one embodiment of the invention, a polymer comprises repeat units
represented by Structural Formula (A). In a first group of such polymers, the sum of
m and p is typically two or greater. When the sum of m and p is greater than two, Z
is typically a phenolic antioxidant, as described above. One preferred phenolic
antioxidant is a 3,5-di-*tert*-butyl-4-hydroxyphenyl group, particularly when X is
20 -C(O)-. For these values of X and Z, m is preferably 2 and n and p are each 0. A
second preferred antioxidant is a 3,4,5-trihydroxyphenyl group, particularly when X
is -C(O)-. Other preferred antioxidants are mono and
di-*tert*-butylated-4-hydroxyphenyl groups, 4-acetoxy-3-*tert*-butylphenyl groups and
3-alkoxycarbonyl-2,6-dihydroxyphenyl groups (e.g.,
25 3-propoxycarbonyl-2,6-dihydroxyphenyl groups), particularly when X is a covalent
bond.

In a second set of these polymer having repeat units represented by
Structural Formula (A), m and p are each 0. When m and p are 0, n is also typically

- 33 -

0. For these values of m , n and p , Z is typically ascorbic acid. X is typically a covalent bond. Alternatively, Z is a 3,4,5-trihydroxyphenyl group or a 4-acetoxy-3-*tert*-butylphenyl group, particularly when X is $-C(O)-$.

In another embodiment of the invention, an antioxidant polymer has repeat units represented by Structural Formula (B). For these polymers, m , n and p are each typically 0. Z is preferably a phenolic antioxidant, specifically a 3,4,5-trihydroxyphenyl, 3,5-di-*tert*-butyl-4-hydroxyphenyl group or a 3,5-di-*tert*-butyl-2-hydroxyphenyl group.

A further embodiment of the invention involves polymers that include repeat units represented by Structural Formula (C). In one group of such polymers, Y is $-O-$ and Z is preferably ascorbic acid, particularly when k is 0. In another group, Y is $-O-$ and Z is a phenolic antioxidant, particularly when k is 0 to 3; more preferably, k is 1. A preferred phenolic antioxidant is a 3,5-di-*tert*-butyl-4-hydroxyphenyl group. Other examples include of phenolic antioxidants include 4-acetoxy-3-*tert*-butylphenyl, 3-*tert*-butyl-4-hydroxyphenyl, 2,6-di-*tert*-butyl-4-mercaptophenyl and 2,6-di-*tert*-butyl-4-hydroxyphenyl groups.

In yet another embodiment of the invention, a polymer includes repeat units represented by Structural Formula (D). Typically, R' is a covalent bond or $-OH$ in such polymers. Other typical values of R' are amide and ester linkages. Preferred Z groups can be phenolic antioxidants, as described above. For these polymers, the phenol hydroxyl group is typically para or *meta* to the group containing Z , more typically para.

Antioxidant polymers described immediately above which are suitable for use in the methods of the present invention have two or more repeat units, preferably greater than about five repeat units. The molecular weight of the polymers disclosed herein can be generally selected to be appropriate for the desired application. Typically, the molecular weight can be greater than about 500 atomic mass units (amu) and less than about 2,000,000 amu, greater than about 1000 amu and less than about 1,000,000 amu, greater than about 1000 amu and less than about 100,000 amu, greater than about 2,000 amu and less than about 10,000 amu, or greater than about 2,000 amu and less than about 5,000 amu.

- 34 -

Antioxidant polymers described immediately above which are suitable for use in the methods of the present invention can be typically insoluble in aqueous media. The solubility of the antioxidant polymers in non-aqueous media (e.g., oils) depends upon the molecular weight of the polymer, such that high molecular weight polymers can be typically sparingly soluble in non-aqueous media. When an antioxidant polymer of the invention can be insoluble in a particular medium or substrate, it can be preferably well-mixed with that medium or substrate.

In another embodiment, the first antioxidants which are suitable for use in the compositions and methods of the present invention are represented by the following structural formula:

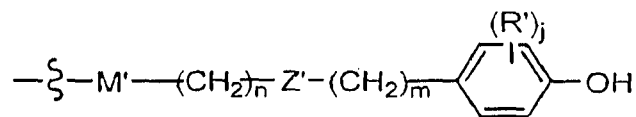

n and m in each occurrence, independently is 0 or a positive integer. Preferably 0 to 18 inclusive.

j in each occurrence, independently is 0, 1, 2, 3 or 4.

Z' in each occurrence, independently is -C(O)O-, -OC(O)-, -C(O)NH-, -NHC(O)-, -NH-, -CH=N-, -N=CH-, -C(O)-, -O-, -S-, -S-S-, -S=N-, -N=S-, -C(S)O-, -OC(S), -OP(O)(OR₄)O-, OP(OR₄)O-, -C(O)OC(O)- or a bond. In one embodiment, Z' is -C(O)O-.

R' in each occurrence, independently is C1-C6 alkyl, -OH, -NH₂, -SH, an optionally substituted aryl, an optionally substituted ester or

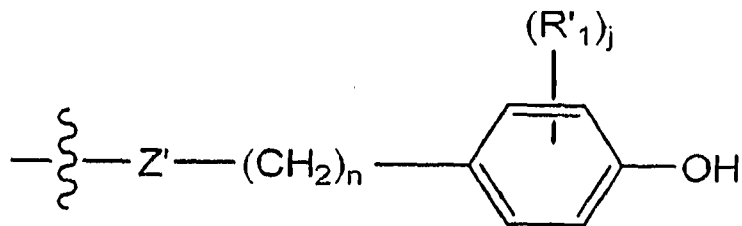

wherein at least one R' adjacent to the -OH group is an optionally substituted bulky alkyl group (e.g., butyl, *sec*-butyl, *tert*-butyl, 2-propyl, 1,1-dimethylhexyl, and the like).

R₁ in each occurrence, independently is C1-C6 alkyl, an optionally substituted aryl, an optionally substituted aralkyl, -OH, -NH₂, -SH, or C1-C6 alkyl ester wherein at least one R₁ adjacent to the -OH group is a bulky alkyl group (e.g., butyl, *sec*-butyl, *tert*-butyl, 2-propyl, 1,1-dimethylhexyl, and the like).)

- 5 M' is H, an optionally substituted aryl, C1-C20 linear or branched alkyl chain with or without any functional group anywhere in the chain,

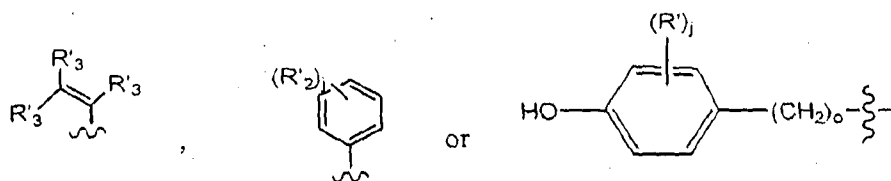

o is 0 or a positive integer,

- 10 R₂ in each occurrence, independently is -H, C1-C6 alkyl, -OH, -NH₂, -SH, optionally substituted aryl, ester, or

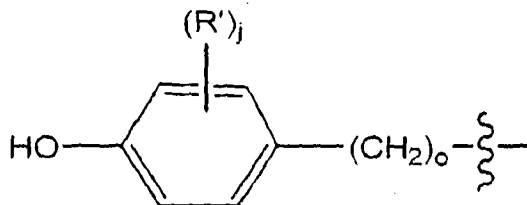

wherein at least one R₂ is -OH.

R₃ in each occurrence, independently is -H, C1-C6 alkyl, optionally substituted aryl, optionally substituted aralkyl -OH, -NH₂, -SH or ester.

- 15 In another embodiment, the first antioxidants which are suitable for use in the compositions and methods of the present invention are represented by the following structural formula:

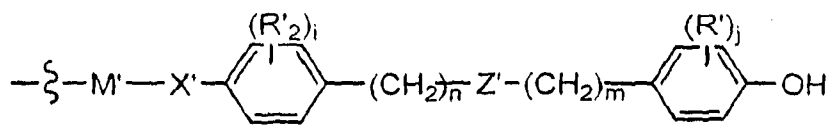

- 20 X' in each occurrence, independently is -C(O)O-, -OC(O)-, -C(O)NH-, -NHC(O)-, -NH-, -CH=N-, -C(O)-, -O-, -S-, -C(O)OC(O)- or a bond.

R'₂ is C1-C6 alkyl, -OH, -NH₂, -SH, aryl, ester, or

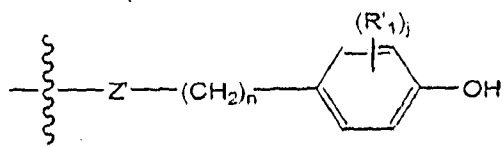

wherein at least one R'₂ is -OH, and the values and preferred values for the remainder of the variables are as described immediately above.

- 5 In certain embodiments Z' is -C(O)O-. In certain other embodiments Z' is -OC(O)-. In certain other embodiments Z' is -C(O)NH-. In certain other embodiments Z' is -NHC(O)-. In certain other embodiments Z' is -NH-. In certain other embodiments Z' is -CH=N-. In certain other embodiments Z' is -N=CH-. In certain other embodiments Z' is -C(O)-. In certain other embodiments Z' is -O-. In
- 10 certain other embodiments Z' is -S-. In certain other embodiments Z' is -S-S-. In certain other embodiments Z' is -S=N-. In certain other embodiments Z' is -N=S-. In certain other embodiments Z' is -C(S)O-. In certain other embodiments Z' is -OC(S)-. In certain other embodiments Z' is -OP(O)(OR₄)O-. In certain other embodiments Z' is OP(OR₄)O-. In certain other embodiments Z' is -C(O)OC(O)-.
- 15 In certain other embodiments Z' is a bond.

In certain embodiments both R' groups adjacent to the -OH group is an optionally substituted bulky alkyl group. In a particular embodiment both R' groups adjacent to the -OH group are *tert*-butyl.

In certain embodiments M' is

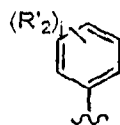

20

In certain embodiments M' is

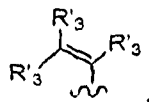

In certain embodiments, at least one R' is

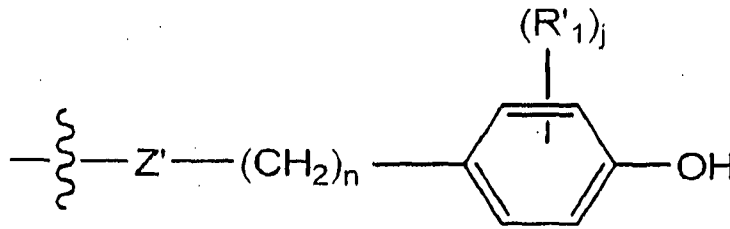

In certain embodiments n is 0.

In certain embodiments m is 1.

In certain embodiments n is 0, m is 1 and Z is -C(O)O-.

- 5 In certain embodiments n is 0, m is 1, Z is -C(O)O- and the two R' groups adjacent to the -OH are t-butyl.

In certain embodiments n is 0, m is 1, Z is -C(O)O-, the two R' groups adjacent to the -OH are t-butyl and M' is

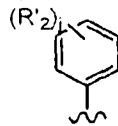

- 10 In certain embodiments n is 0, m is 1, Z is -C(O)O-, the two R' groups adjacent to the -OH are t-butyl, M' is

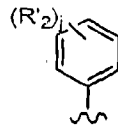

and the R'₂ in the para position is -OH.

- 15 In certain embodiments n is 0, m is 1, Z is -C(O)O-, the two R' groups adjacent to the -OH are t-butyl, M' is

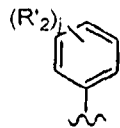

the R'₂ in the para position is -OH and an adjacent R'₂ is -OH..

In certain embodiments n is 0, m is 1, Z is -C(O)O-, the two R' groups

- 38 -

adjacent to the -OH are t-butyl, M' is

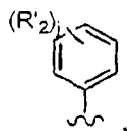

the R'_2 in the para position is -OH and the two adjacent R'_2 are -OH..

In certain embodiments n is 0, m is 1, Z is -C(O)O-, the two R' groups
5 adjacent to the -OH are t-butyl, M' is

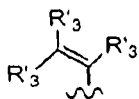

In certain embodiments n is 0, m is 1, Z is -C(O)O-, the two R' groups
adjacent to the -OH are t-butyl, M' is

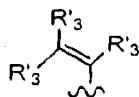

10 and R_3 is -H.

Specific examples of compounds and polymers which are suitable for use in the compositions and methods of the present invention are represented by one of the following structural formulas:

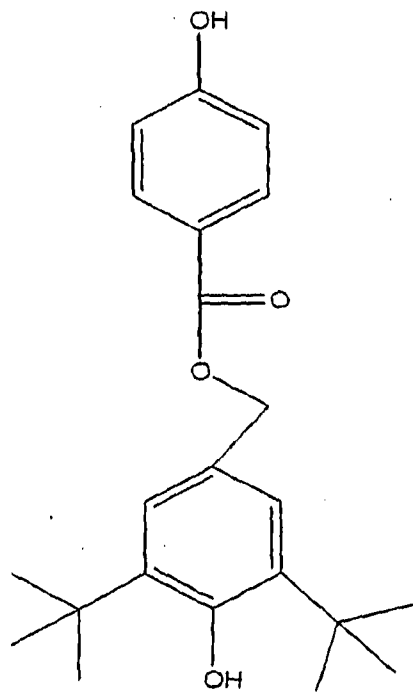
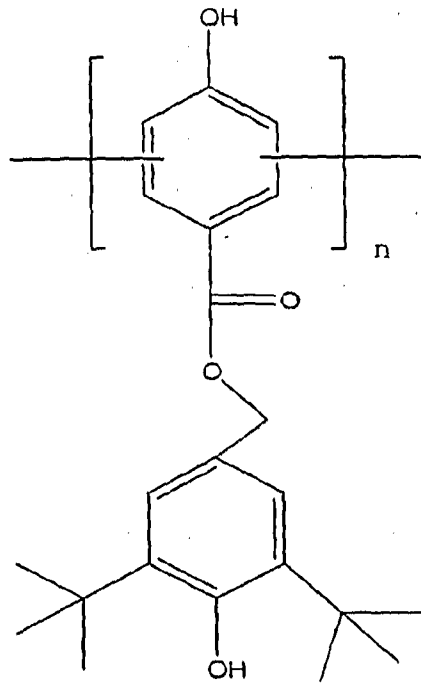

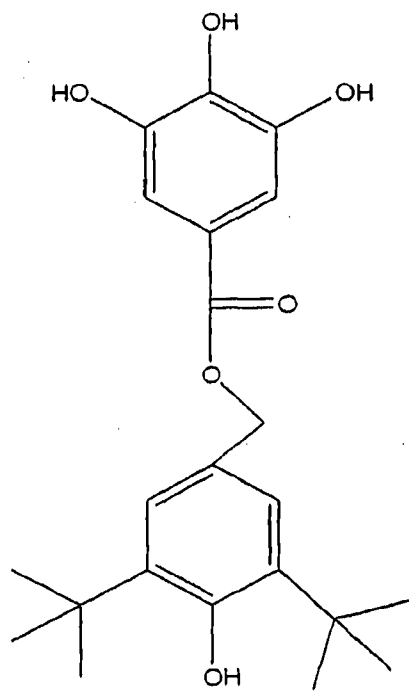
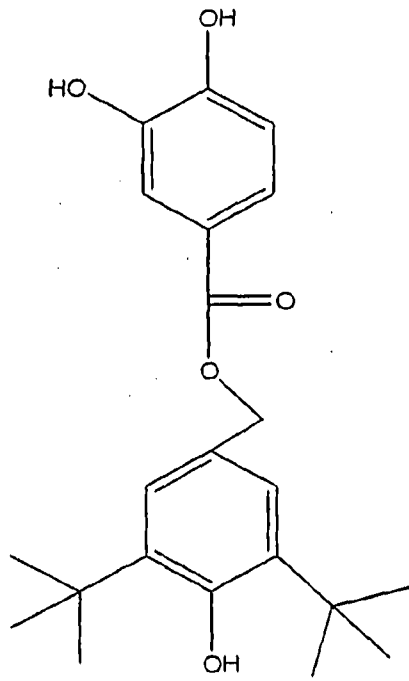

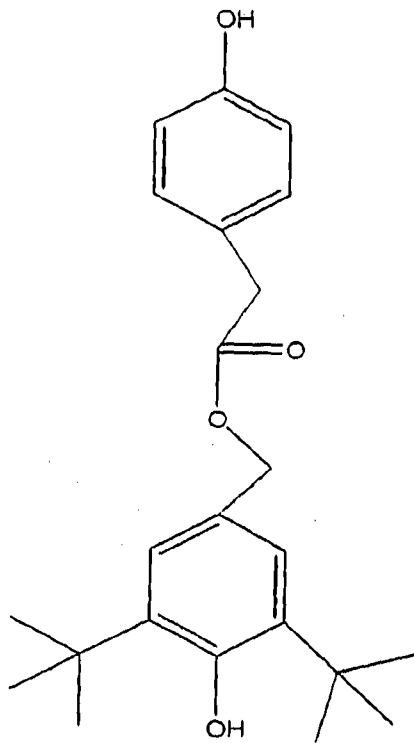
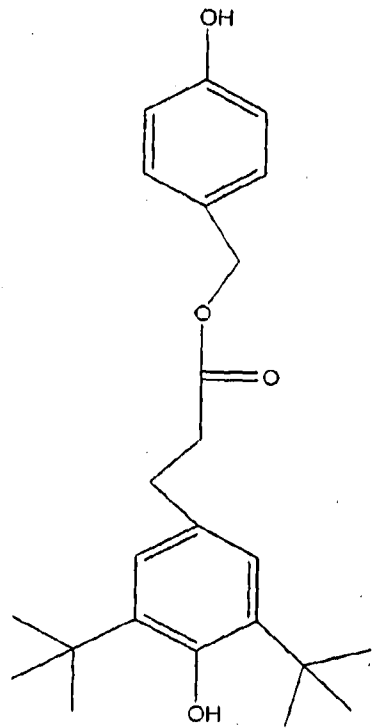

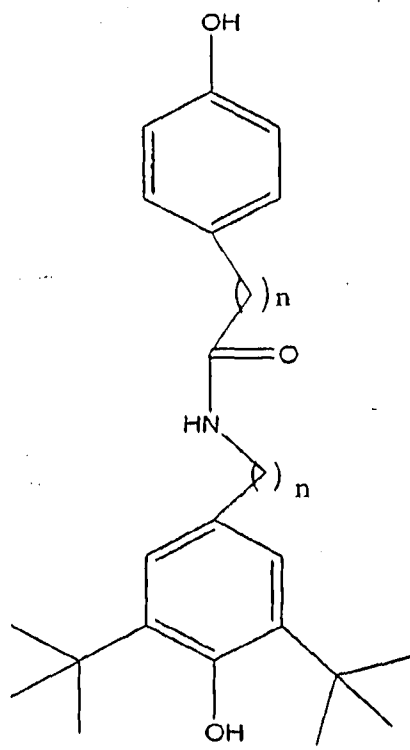
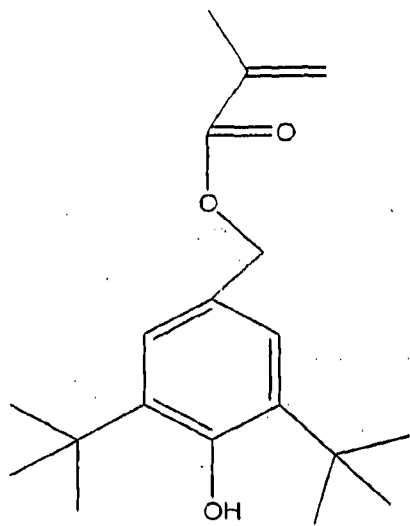

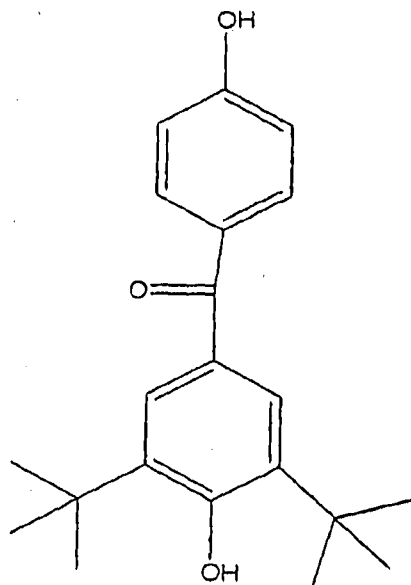
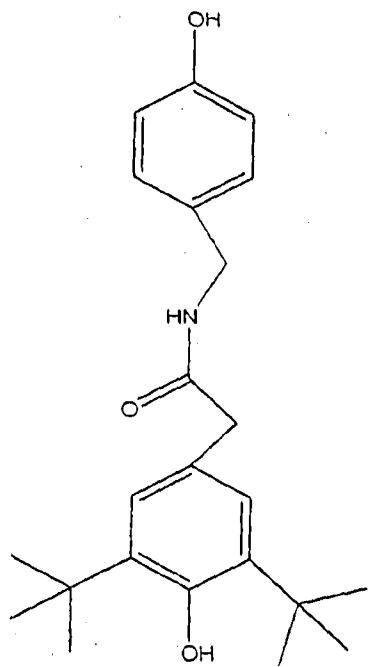

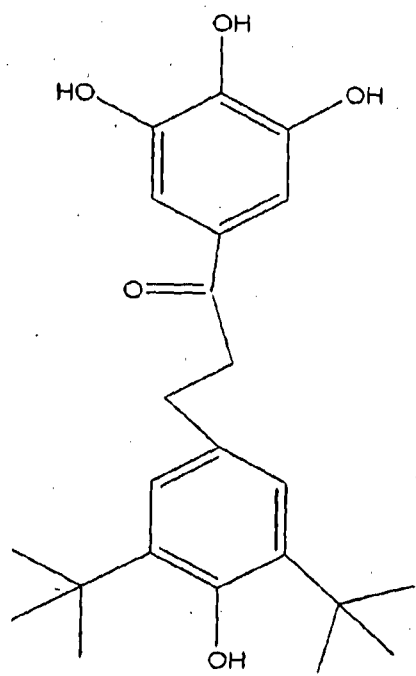
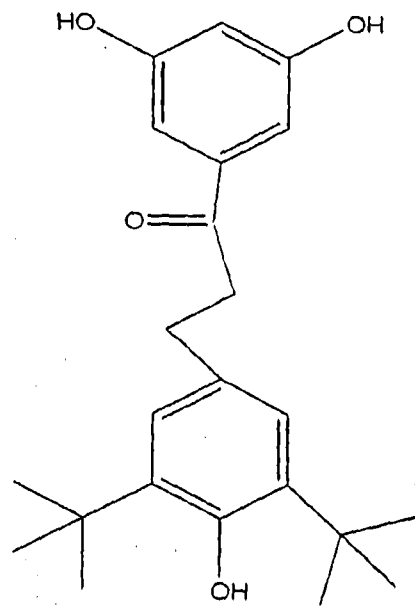

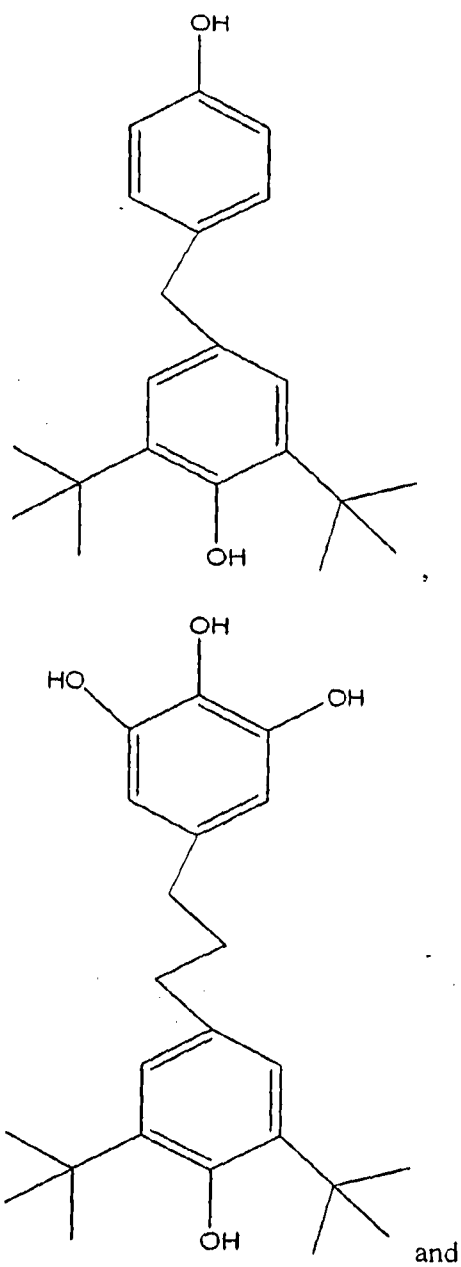

- 46 -

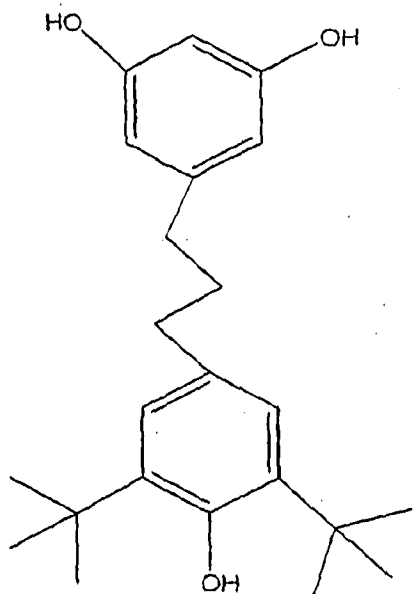

In another embodiment, the first antioxidants which are suitable for use in the compositions and methods of the present invention include a macromonomer represented by Structural Formula I and I'.

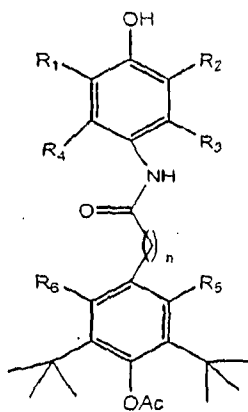

I

5

In I, R and R₁-R₆ are independently -H, -OH, or a C₁-C₁₀ optionally substituted linear or branched alkyl group. n is an integer from 0 to 24.

- 47 -

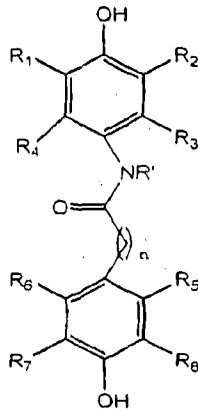

I'

In I', each of R and R₁-R₈ are independently -H, -OH, or a C1-C10 alkyl group. n is an integer from 0 to 24. R' is -H, optionally substituted C1-C20 alkyl or optionally substituted aryl group.

In another embodiment, the first antioxidants which are suitable for use in the compositions and methods of the present invention include a macromonomer represented by Structural Formula III and an antioxidant polymer represented by Structural Formula IV. The variables are as defined above.

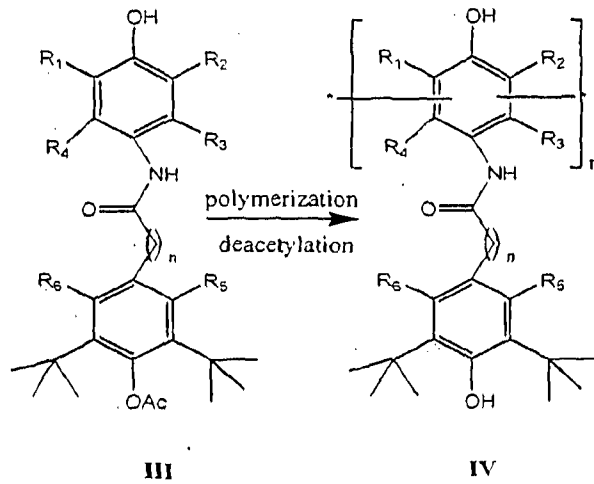

III

IV

- 48 -

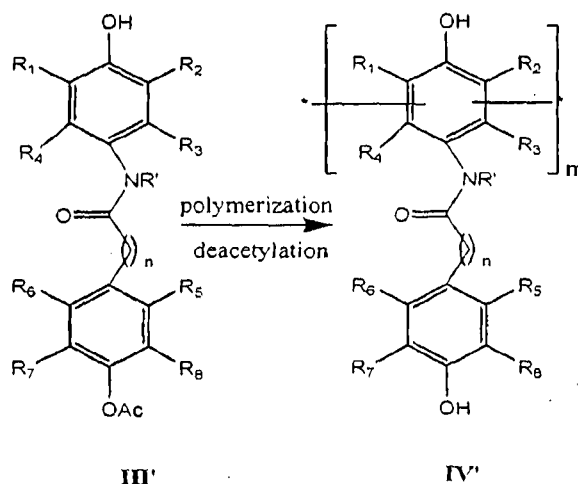

In **III'** and **IV'** each of R_i and R_1 - R_8 are independently $-\text{H}$, $-\text{OH}$, or a C1-C10 alkyl group. n is an integer from 0 to 24. m is an integer equal to 2 or greater. R' is $-\text{H}$, optionally substituted C1-C20 alkyl or optionally substituted aryl group.

5 In **III** and **IV** the variables are as defined above.

Repeat units of the antioxidant polymers as described immediately above suitable for use in the compositions and methods of the present invention include substituted benzene molecules. These benzene molecules are typically based on phenol or a phenol derivative, such that they have at least one hydroxyl or ether
 10 functional group. Preferably, the benzene molecules have a hydroxyl group. The hydroxyl group can be a free hydroxyl group and can be protected or have a cleavable group attached to it (e.g., an ester group). Such cleavable groups can be released under certain conditions (e.g., changes in pH), with a desired shelf life or with a time-controlled release (e.g., measured by the half-life), which allows one to
 15 control where and/or when an antioxidant polymer can exert its antioxidant effect. The repeat units can also include analogous thiophenol and aniline derivatives, e.g., where the phenol $-\text{OH}$ can be replaced by $-\text{SH}$, $-\text{NH}-$, and the like.

Substituted benzene repeat units of an antioxidant polymer as described immediately above suitable for use in the compositions and methods of the present
 20 invention are also typically substituted with a bulky alkyl group or an n -alkoxycarbonyl group. Preferably, the benzene monomers are substituted with a bulky alkyl group. More preferably, the bulky alkyl group is located *ortho* or *meta* to a hydroxyl group on the benzene ring, typically *ortho*. A "bulky alkyl group" is

- 49 -

defined herein as an alkyl group that is branched *alpha*- or *beta*- to the benzene ring. Preferably, the alkyl group is branched alpha to the benzene ring. More preferably, the alkyl group is branched twice alpha to the benzene ring, such as in a *tert*-butyl group. Other examples of bulky alkyl groups include isopropyl, 2-butyl, 3-pentyl, 1,1-dimethylpropyl, 1-ethyl-1-methylpropyl and 1,1-diethylpropyl. The bulky alkyl groups are preferably unsubstituted, but they can be substituted with a functional group that does not interfere with the antioxidant activity of the molecule or the polymer. Straight chained alkoxy carbonyl groups include methoxycarbonyl, ethoxycarbonyl, n-propoxycarbonyl, n-butoxycarbonyl and n-pentoxycarbonyl. n-propoxycarbonyl is a preferred group. Similar to the bulky alkyl groups, n-alkoxy carbonyl groups are optionally substituted with a functional group that does not interfere with the antioxidant activity of the molecule or the polymer.

Antioxidant polymers as described immediately above suitable for use in the compositions and methods of the present invention have two or more repeat units, preferably greater than about five repeat units. The molecular weight of the polymers disclosed herein can be generally selected to be appropriate for the desired application. Typically, the molecular weight can be greater than about 500 atomic mass units (amu) and less than about 2,000,000 amu, greater than about 1000 amu and less than about 100,000, greater than about 2,000 amu and less than about 10,000, or greater than about 2,000 amu and less than about 5,000 amu.

Antioxidant polymers as described immediately above suitable for use in the compositions and methods of the present invention can be either homopolymers or copolymers. A copolymer preferably contains two or more or three or more different repeating monomer units, each of which has varying or identical antioxidant properties. The identity of the repeat units in a copolymer can be chosen to modify the antioxidant properties of the polymer as a whole, thereby giving a polymer with tunable properties. The second, third and/or further repeat units in a copolymer can be either a synthetic or natural antioxidant.

Antioxidant polymers as described immediately above suitable for use in the compositions and methods of the present invention are typically insoluble in aqueous media. The solubility of the antioxidant polymers in non-aqueous media (e.g., oils) depends upon the molecular weight of the polymer, such that high

molecular weight polymers are typically sparingly soluble in non-aqueous media. When an antioxidant polymer of the invention can be insoluble in a particular medium or substrate, it can be preferably well-mixed with that medium or substrate.

Antioxidant polymers as described immediately above suitable for use in the compositions and methods of the present invention can be branched or linear, but are preferably linear. Branched antioxidant polymers can only be formed from benzene molecules having three or fewer substituents (e.g., three or more hydrogen atoms).

In another embodiment, the antioxidants which are suitable for use in the compositions and methods of the present invention include macromolecule antioxidants represented by Structural Formula J or J':

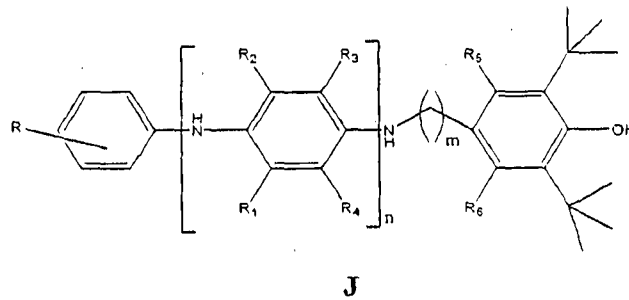

In J, R and R₁-R₆ are independently -H, -OH, or a C1-C10 optionally substituted linear or branched alkyl group. n is an integer from 0 to 24.

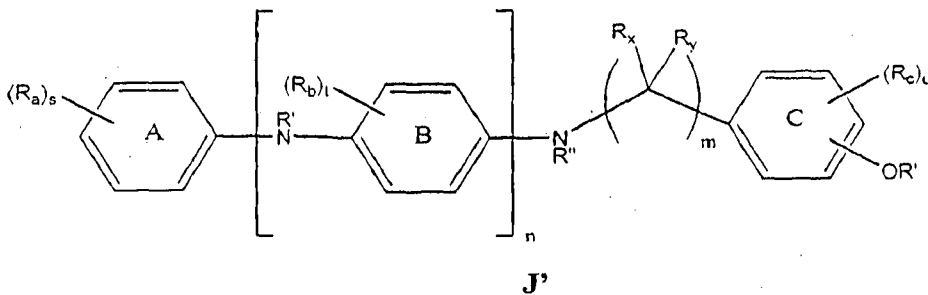

In J' Each R_a is independently an optionally substituted alkyl. Each R_b is independently an optionally substituted alkyl. Each R_c is independently an optionally substituted alkyl or an optionally substituted alkoxy carbonyl. R_x is -H or an optionally substituted alkyl. R_y is -H or an optionally substituted alkyl. Each R' is independently -H or an optionally substituted alkyl. R'' is -H, an optionally

substituted alkyl, an optionally substituted aryl or an optionally substituted aralkyl.
 n is an integer from 1 to 10. m is an integer from 1 to 10. s is an integer from 0 to 5.
 t is an integer from 0 to 4. u is an integer from 1 to 4. With the proviso that when n
 is 1, then either ring C is not:

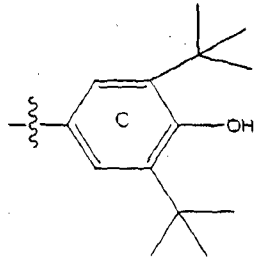

5

s is not 0, or R'' is not -H.

Specific examples of macromolecule antioxidants represented by Structural
 Formula J which are suitable for use in the compositions and methods of the present
 10 invention are represented by one of the following structural formulas:

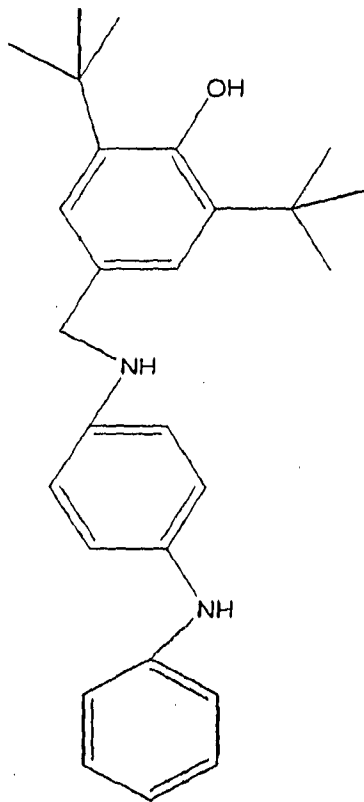

- 52 -

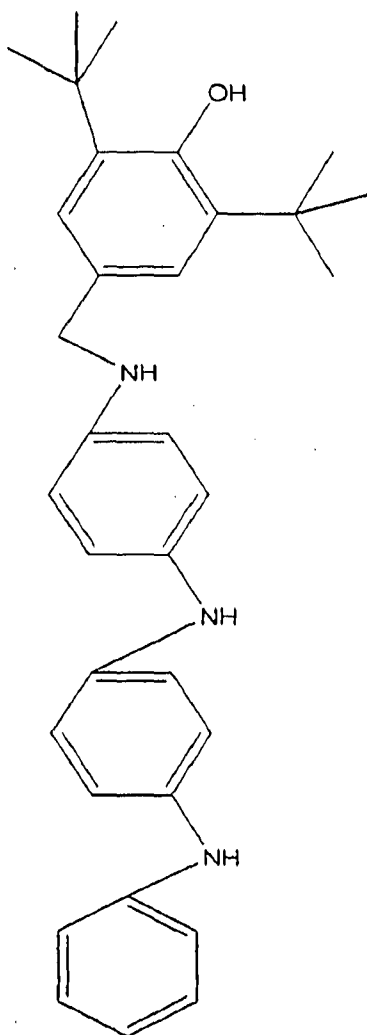

and

- 53 -

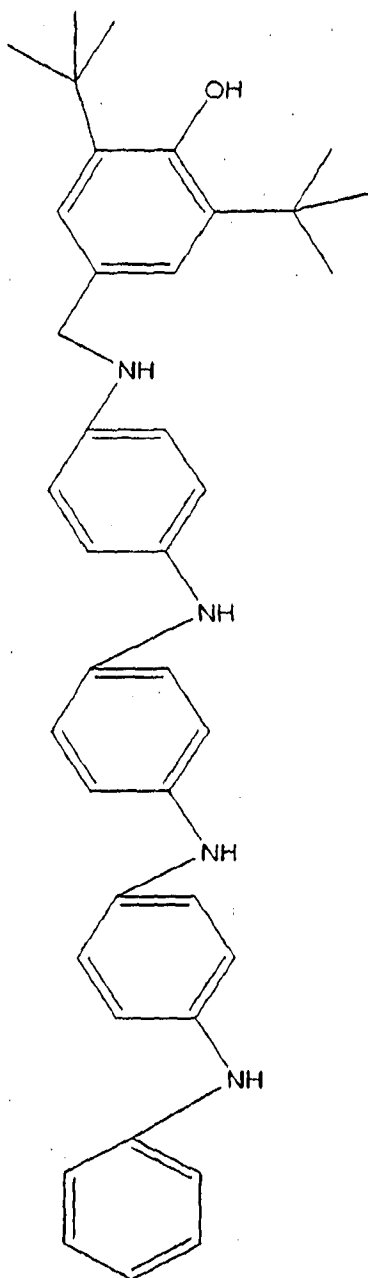

In another embodiment, the antioxidants which are suitable for use in the compositions and methods of the present invention include macromolecular antioxidants represented by structural formula J¹:

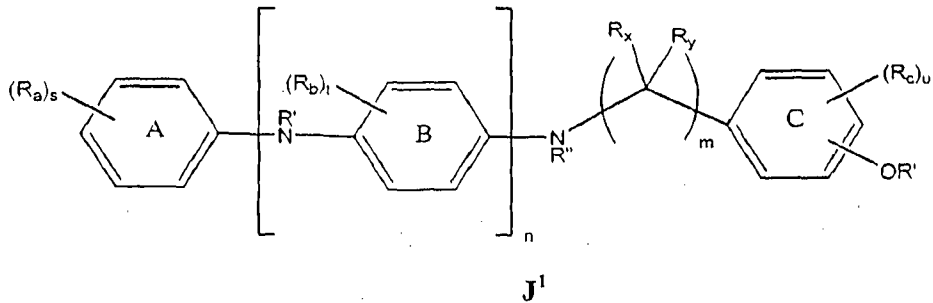

Each R_a is independently an optionally substituted alkyl. Each R_b is independently an optionally substituted alkyl. Each R_c is independently an optionally substituted alkyl or an optionally substituted alkoxycarbonyl. R_x is -H or an optionally substituted alkyl. R_y is -H or an optionally substituted alkyl. Each R' is independently -H or an optionally substituted alkyl. R'' is -H, an optionally substituted alkyl, an optionally substituted aryl or an optionally substituted aralkyl. n is an integer from 1 to 10. m is an integer from 1 to 10. s is an integer from 0 to 5. t is an integer from 0 to 4. u is an integer from 1 to 4. With the proviso that when n is 1, then either ring C is not:

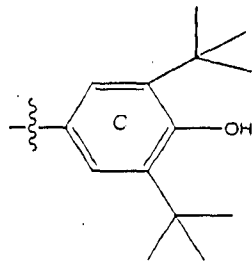

s is not 0, or R'' is not -H.

In one embodiment the variables in J^1 are as described as follows:

Each R_a is independently an optionally substituted alkyl. In one embodiment, each R_a is independently a C1-C20 alkyl. In another embodiment, each R_a is independently a C1-C10 alkyl. In another embodiment, each R_a is independently selected from the group consisting of:

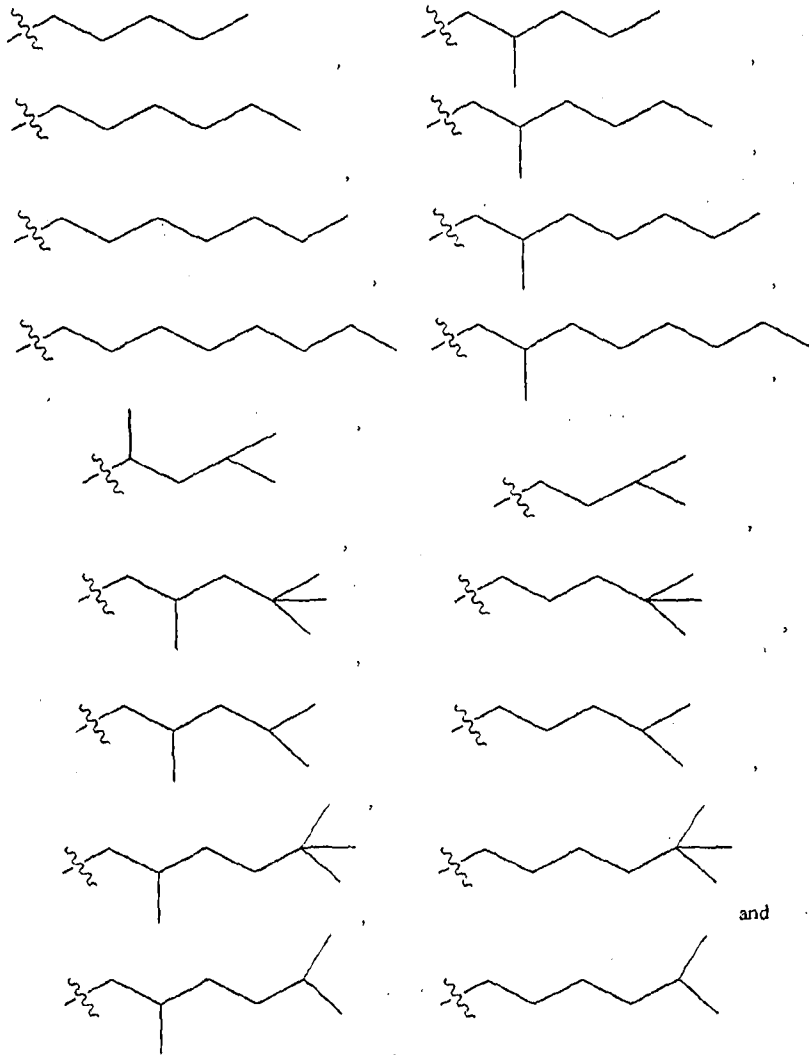

and

In another embodiment R_d is:

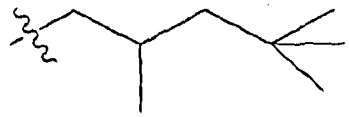

Each R_b is independently an optionally substituted alkyl.

5 Each R_c is independently an optionally substituted alkyl or an optionally substituted alkoxy carbonyl. In one embodiment, each R_c is independently a C1-C10 alkyl.

R_x is -H or an optionally substituted alkyl. R_y is -H or an optionally substituted alkyl. In one embodiment, R_x and R_y are -H.

- 56 -

Each R' is independently -H or an optionally substituted alkyl. In one embodiment, one R' is -H. In another embodiment, both R' are -H.

R'' is -H, an optionally substituted alkyl, an optionally substituted aryl or an optionally substituted aralkyl. In one embodiment, R'' is -H, a C1-C20 alkyl or an optionally substituted aralkyl. In another embodiment, R'' is -H, a C1-C10 alkyl or a substituted benzyl group. In yet another embodiment, R'' is -H. In yet another embodiment, R'' is:

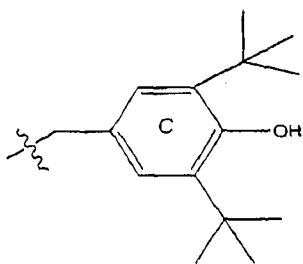

In yet another embodiment R'' is selected from the group consisting of:

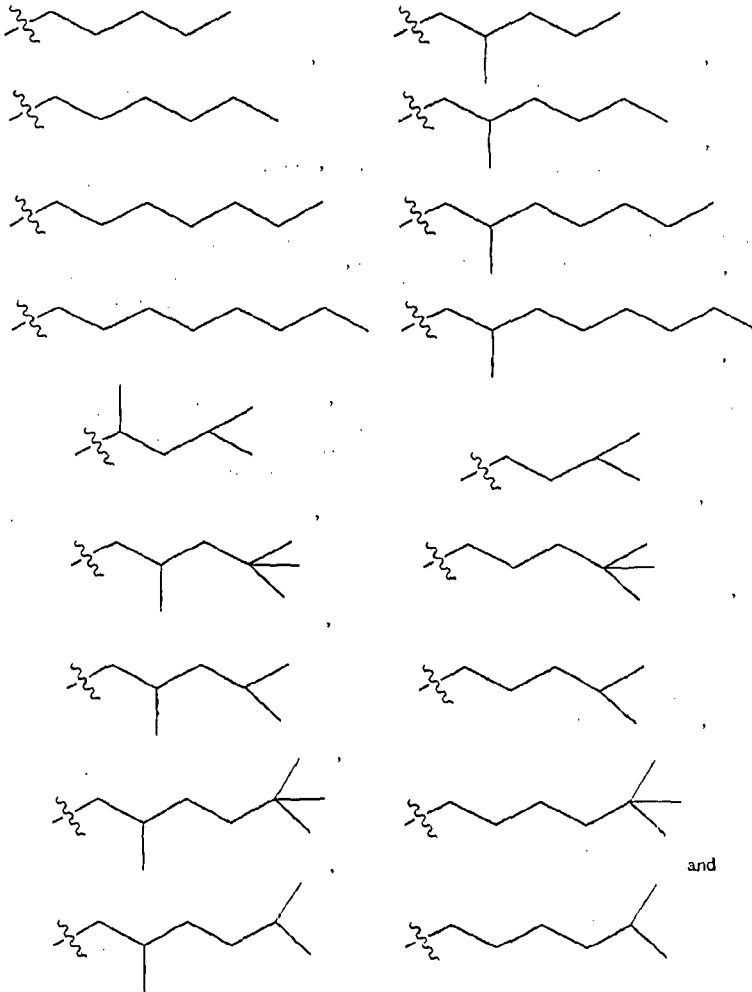

In yet another embodiment R'' is:

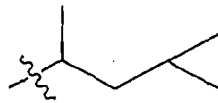

n is an integer from 1 to 10. In one embodiment, n is an integer from 1 to 6.

5 In another embodiment, n is 1. In yet another embodiment, n is 2. In yet another embodiment, n is 3. In yet another embodiment, n is 4.

m is an integer from 1 to 10. In one embodiment, m is 1 or 2. In another embodiment, m is 1.

s is an integer from 0 to 5. In one embodiment, s is 0 or 1. In another
10 embodiment, s is 0.

t is an integer from 0 to 4. In one embodiment, t is 0.

u is an integer from 1 to 4. In one embodiment, u is 1 or 2.

In certain embodiments for antioxidants represented by J^1 , when n is 1, the either ring C is not:

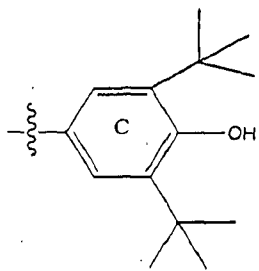

5 s is not 0, or R'' is not $-H$.

In one embodiment in J^1 :

Each R_a is independently a C1-C20 alkyl. Each R_c is independently a C1-C10 alkyl. R'' is $-H$, a C1-C20 alkyl or an optionally substituted aralkyl, and the remainder of the variables are as described above for structural formula (I).

10 In another embodiment in J^1 : one R' is $-H$, t is 0, R_x and R_y are $-H$ and the compounds are represented by structural formula J^2 :

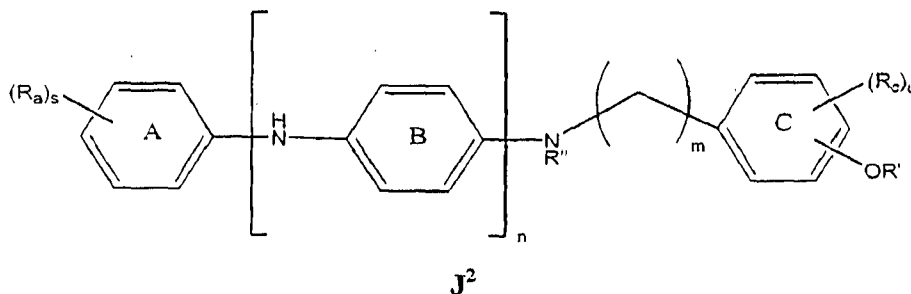

15 and the remainder of the variables are as described in the immediately preceding paragraph or for structural formula J^1

In another embodiment in J^2 :

m is 1 or 2.

s is 0 or 1.

20 u is 1 or 2, and the remainder of the variables are as described in the immediately preceding paragraph or for J^1 .

In another embodiment in J^2 : both R' are $-H$ and m is 1 and the compounds are represented by structural formula J^3 :

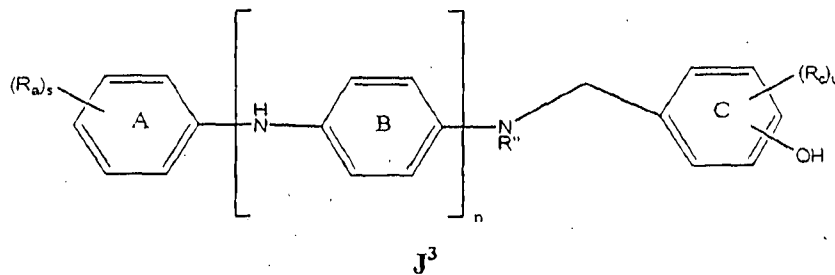

and the remainder of the variables are as described in the immediately preceding paragraph or for structural formula J^1 or J^2 .

5 In another embodiment in J^3 :

Each R_a is independently a C1-C10 alkyl.

R'' is -H, a C1-C10 alkyl or a substituted benzyl group.

n is an integer from 1 to 6, and the remainder of the variables are as described in the immediately preceding paragraph or for structural formula J^1 or J^2 .

10 In another embodiment in J^3 : n is 1, s is 0 and R'' is -H and the compounds are represented by structural formula J^4 :

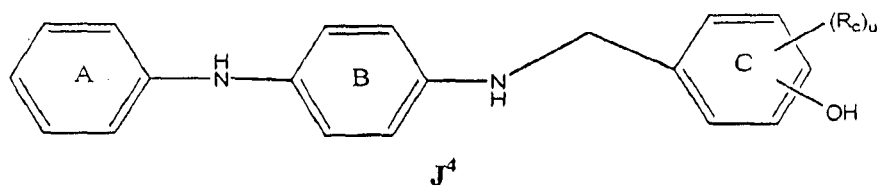

with the proviso that ring C is not:

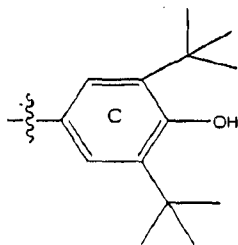

15

and the remainder of the variables are as described above for structural formula J^1 , J^2 , or J^3 .

In certain embodiments of the present invention the antioxidants which are suitable for use in the compositions and methods of the present invention include
20 structural formula J^3 or J^4 represented by the following structural formulas:

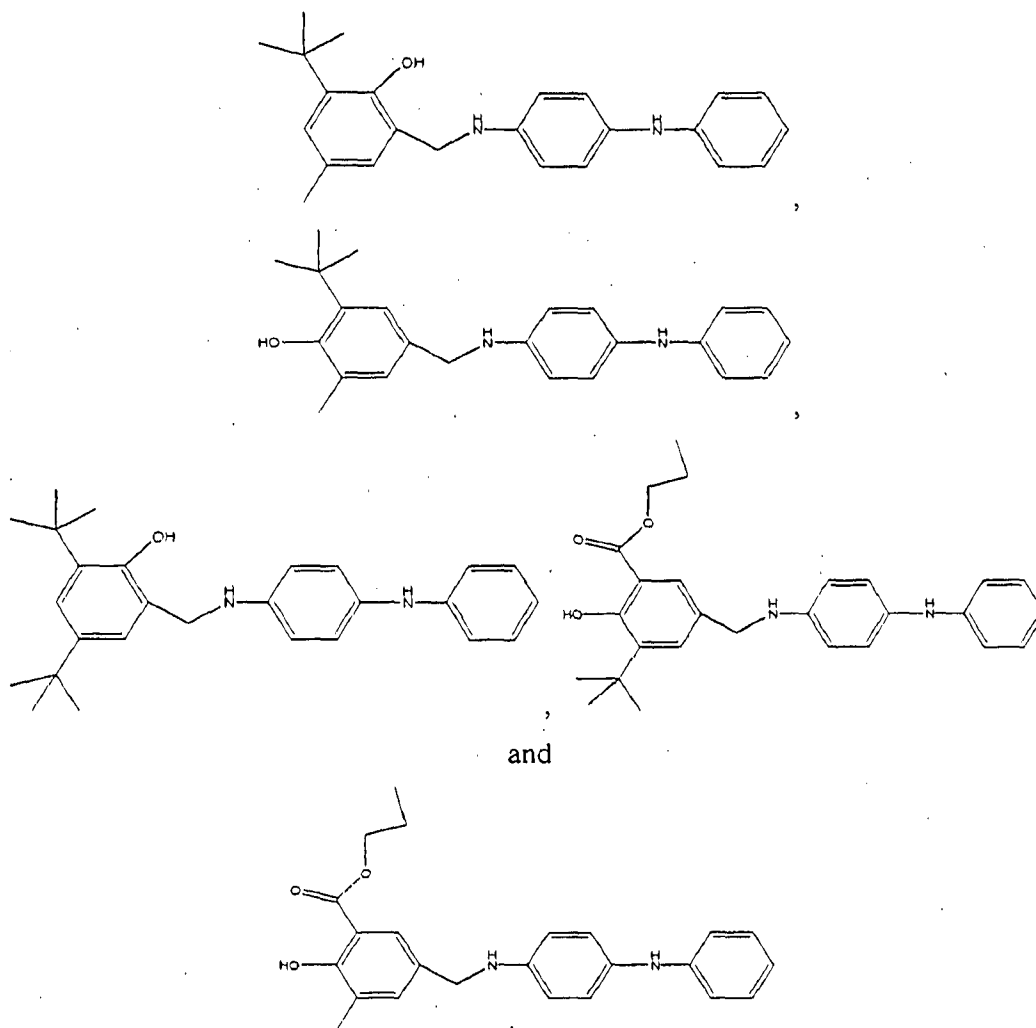

5

In another embodiment in J^3 : n is 1 and the compounds are represented by structural formula J^5 :

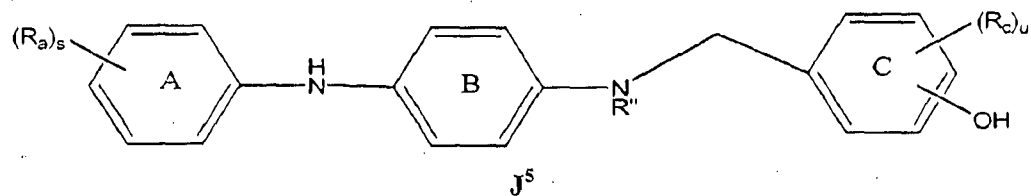

10 and the remainder of the variables are as described above for structural formula J^1 , J^2 , or J^3 .

In another embodiment of the present invention for compounds represented by structural formula J^3 : s is 0 and the compounds are represented by structural formula J^6 .

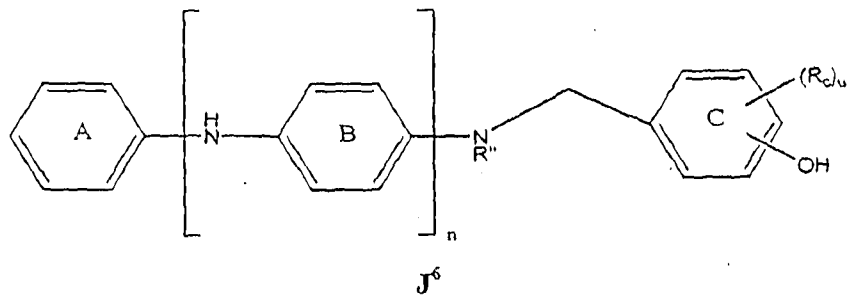

and the remainder of the variables are as described above for structural formula J^1 , J^2 , or J^3 .

- 5 In another embodiment of the present invention for compounds represented by structural formula J^3 : R'' is -H and the compounds are represented by structural formula J^7 :

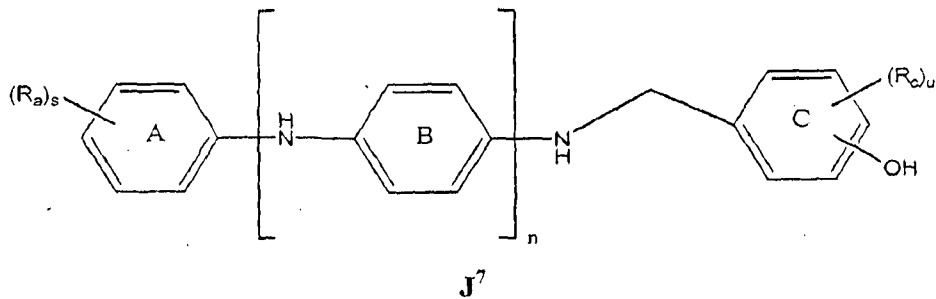

10

and the remainder of the variables are as described above for structural formula J^1 , J^2 or J^3 .

- 15 In certain embodiments of the present invention the compounds represented by structural formula J^3 , J^5 , J^6 or J^7 are represented by the following structural formulas:

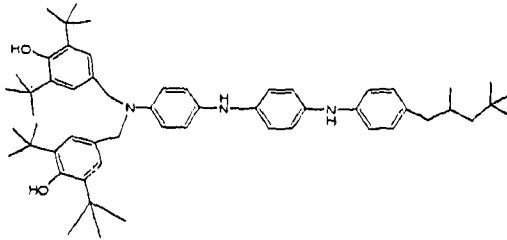
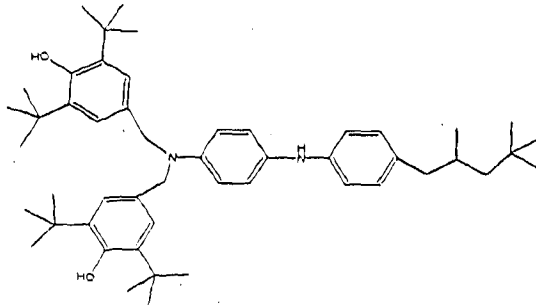
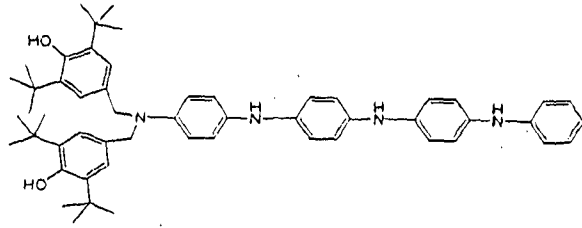
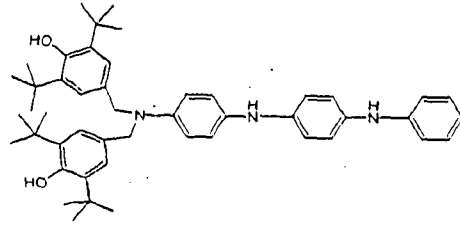

5

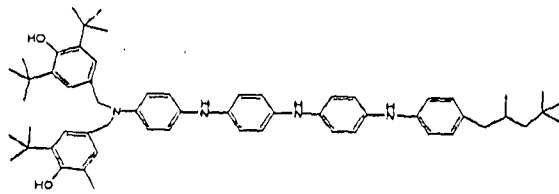
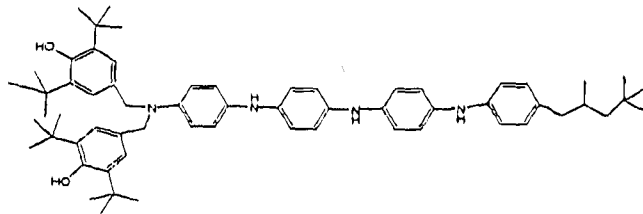

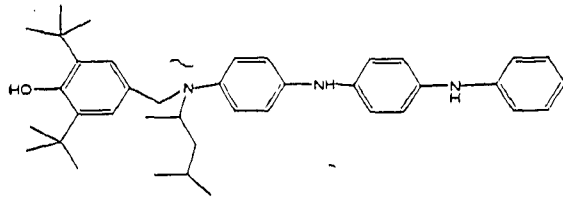
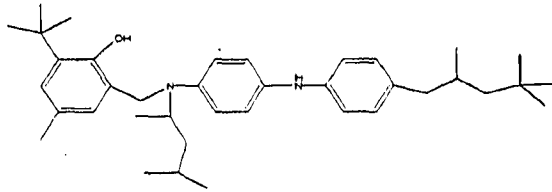
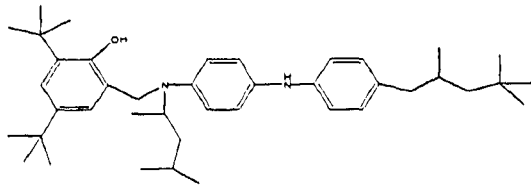
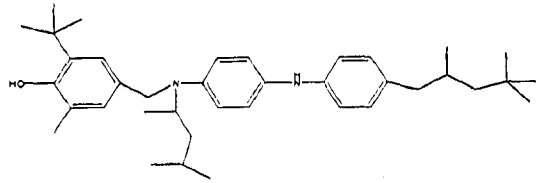
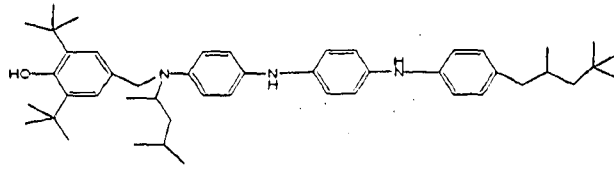
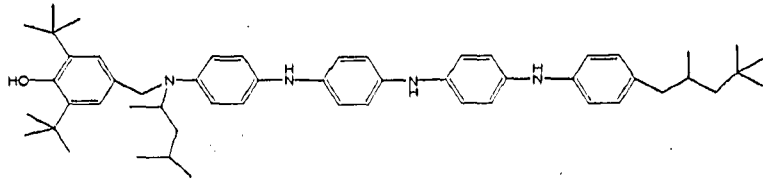
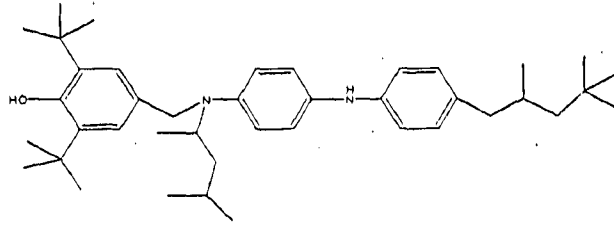

5

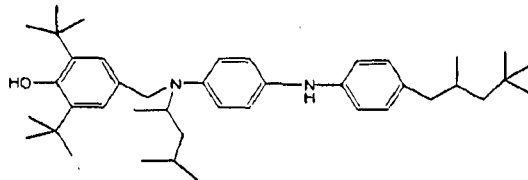
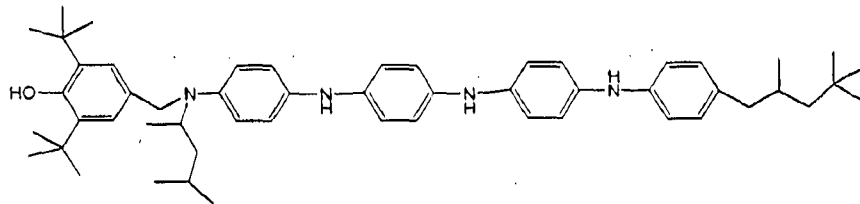
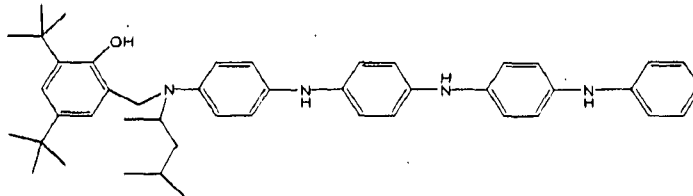
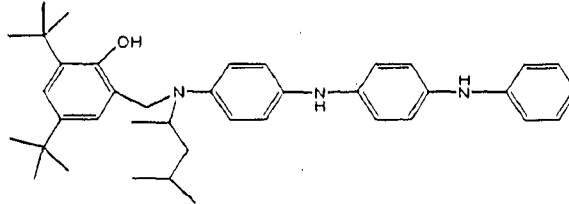
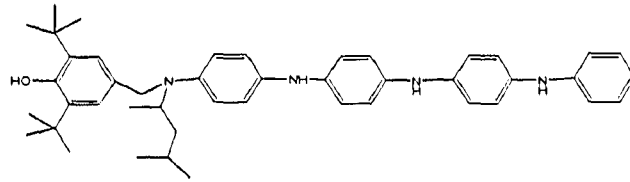

5

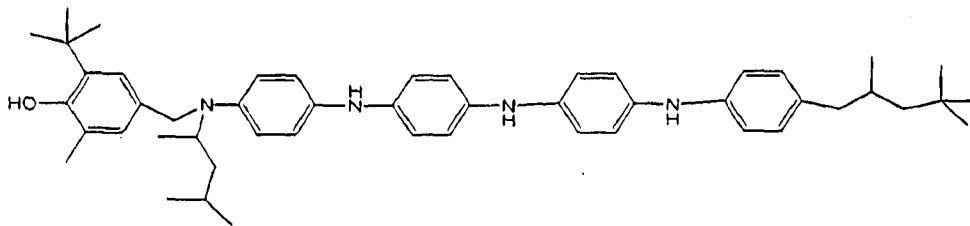
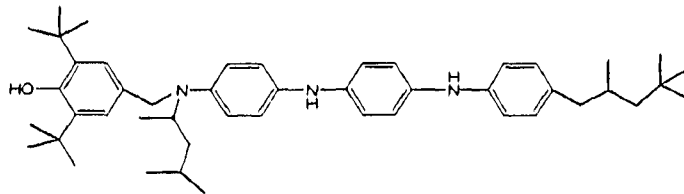

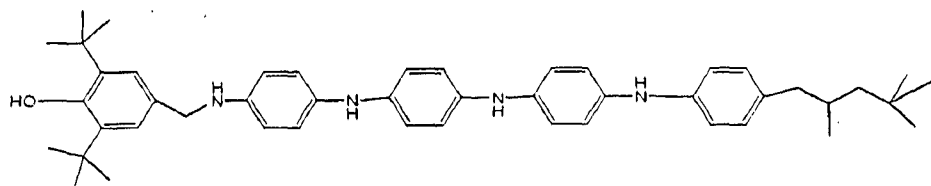
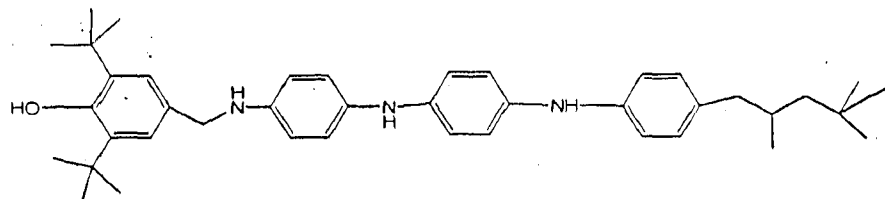
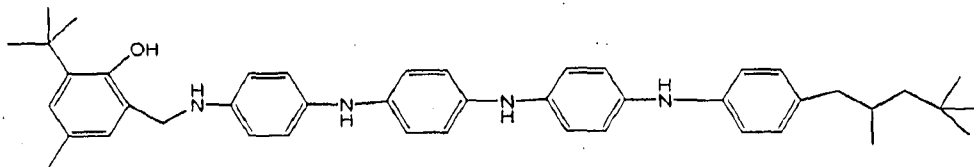
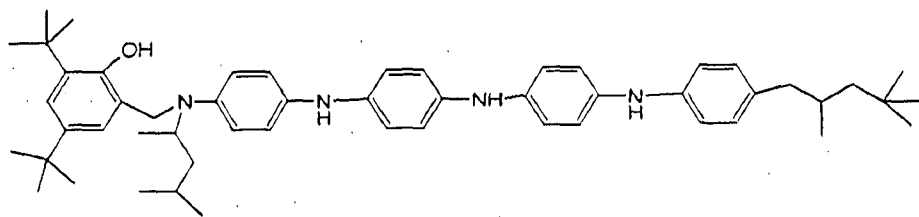

and

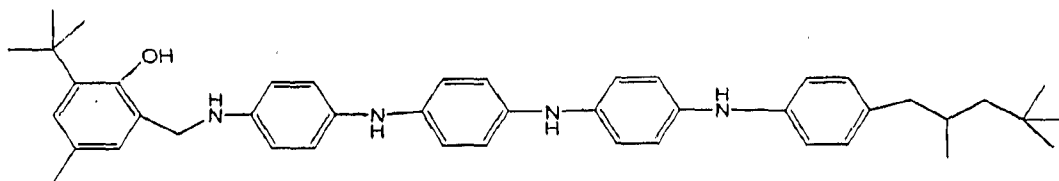

5

In another embodiment of the present invention for compounds represented by structural formula J^3 : R'' is -H and n is 1 and the compounds are represented by structural formula J^8 :

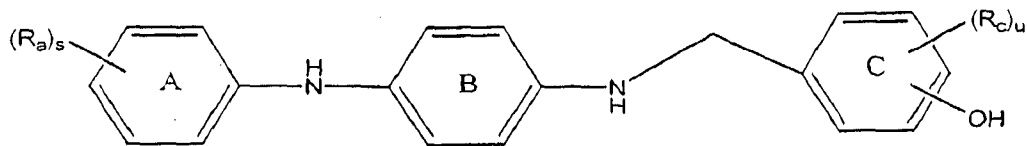

10

J^8

and the remainder of the variables are as described above for structural formula J^1 , J^2 or J^3 .

In certain embodiments of the present invention the compounds represented by structural formula J^3 or J^8 are represented by the following structural formulas:

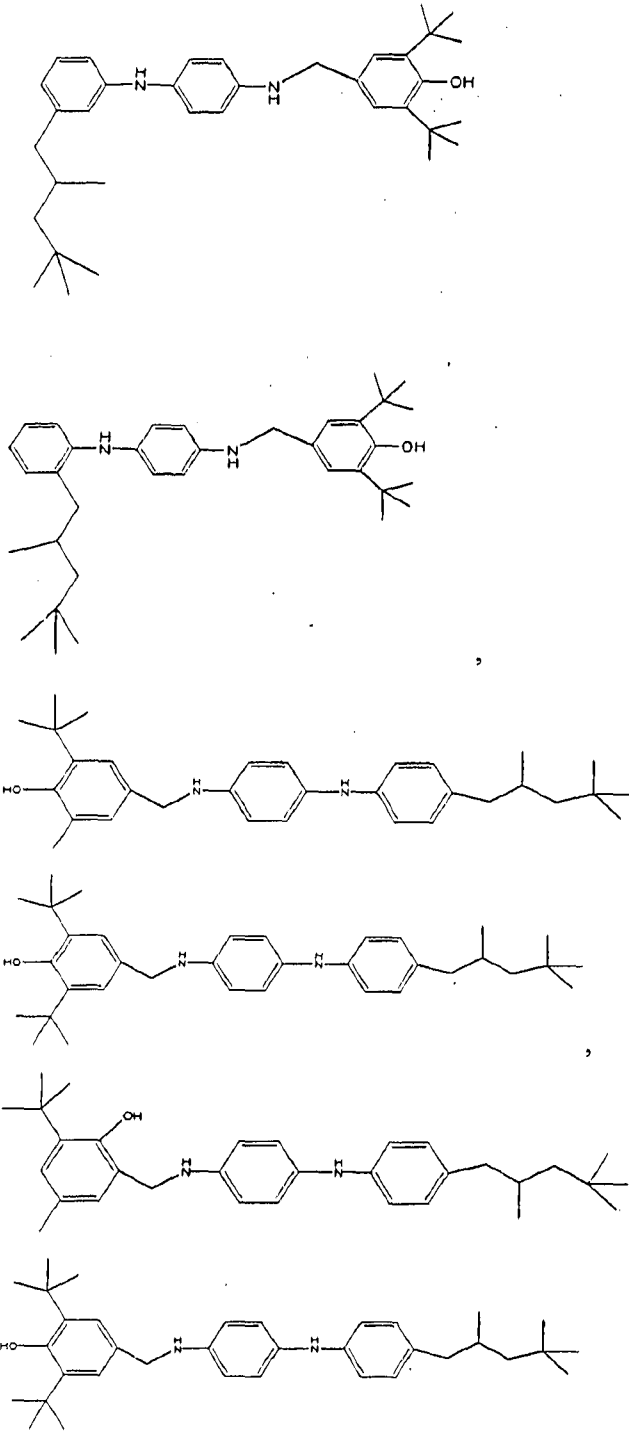

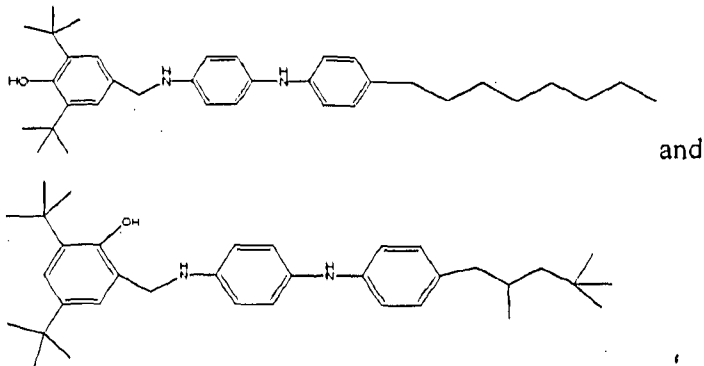

In another embodiment of the present invention for compounds represented by structural formula J^3 : s is 0 and R'' is -H and the compounds are represented by structural formula J^9 :

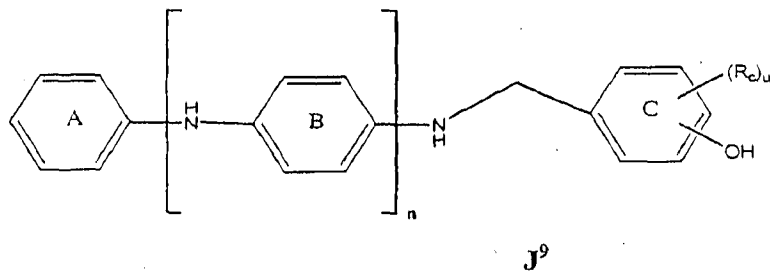

and the remainder of the variables are as described above for structural formula J^1 , J^2 or J^3 .

In certain embodiments of the present invention the compounds represented by structural formula J^3 or J^9 are represented by the following structural formulas:

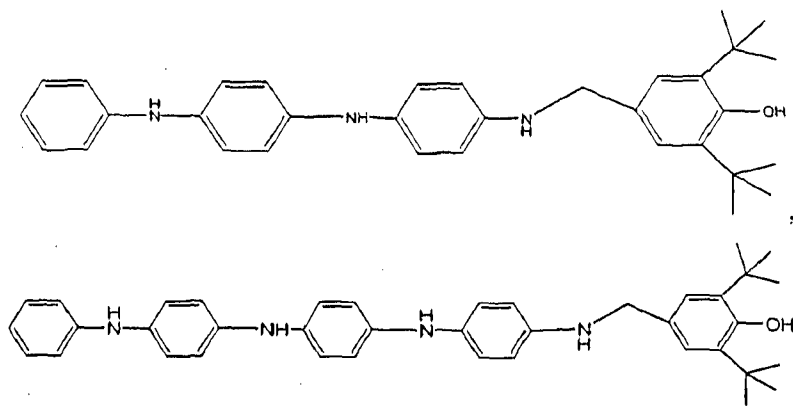

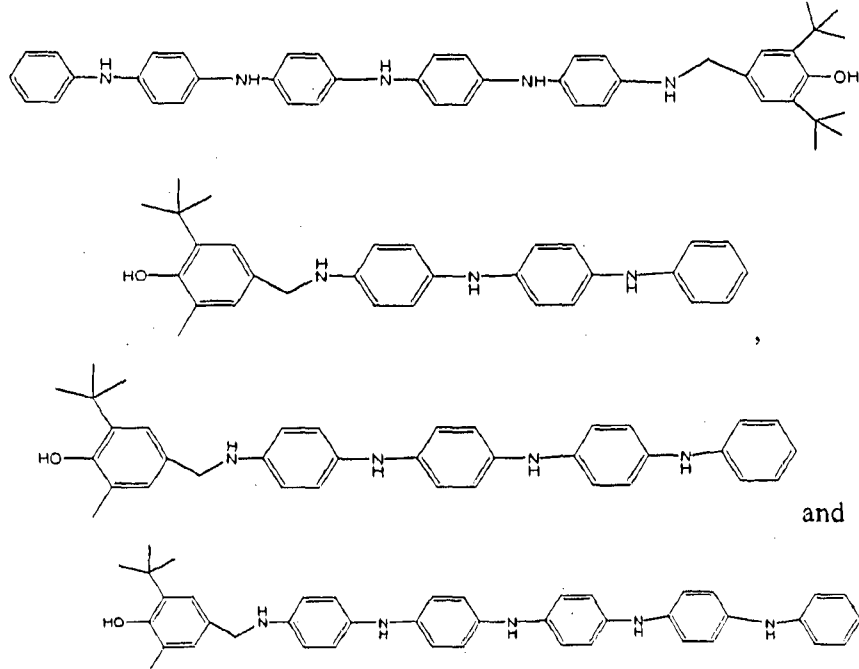

5

In another embodiment of the present invention for compounds represented by structural formula J^3 : s is 0 and n is 0 and the compounds are represented by structural formula J^{10} :

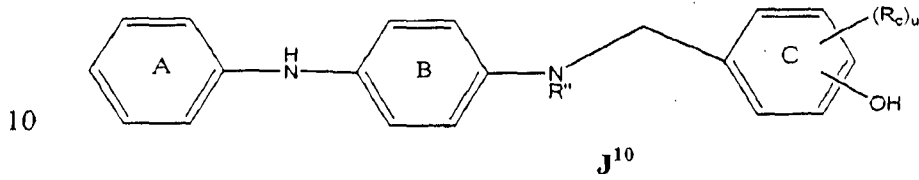

10

and the remainder of the variables are as described above for structural formula J^1 , J^2 or J^3 .

In certain embodiments of the present invention the compounds represented by structural formula J^3 or J^{10} are represented by the following structural formulas:

15

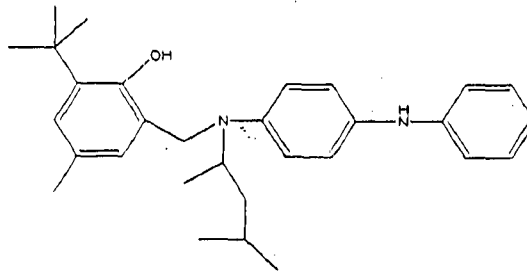
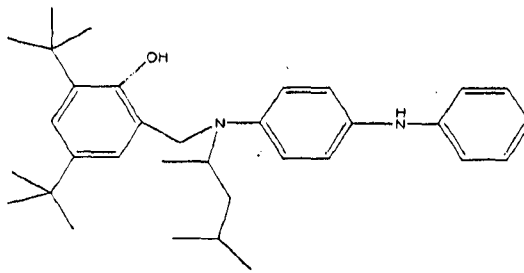
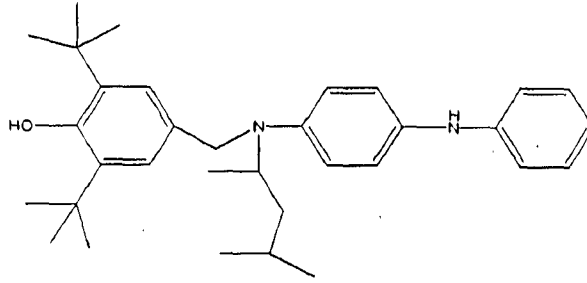
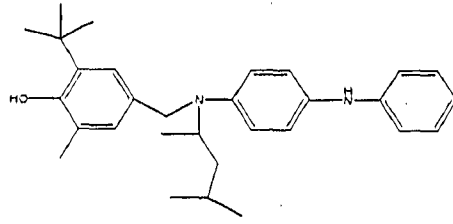

and

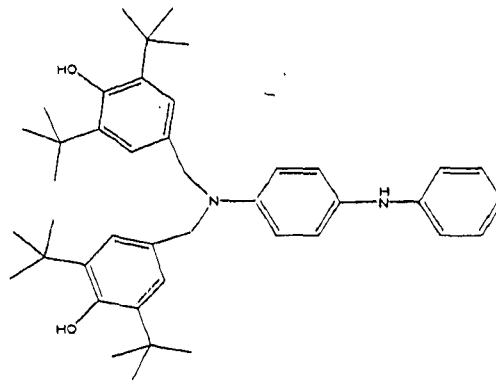

In another embodiment of the present invention the antioxidants which are suitable for use in the compositions and methods of the present invention include compounds represented by the following structural formulas:

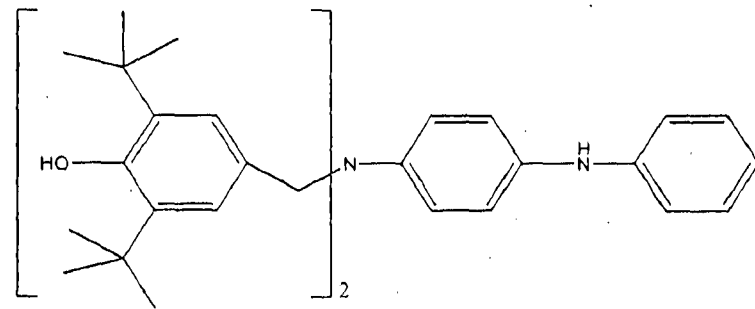
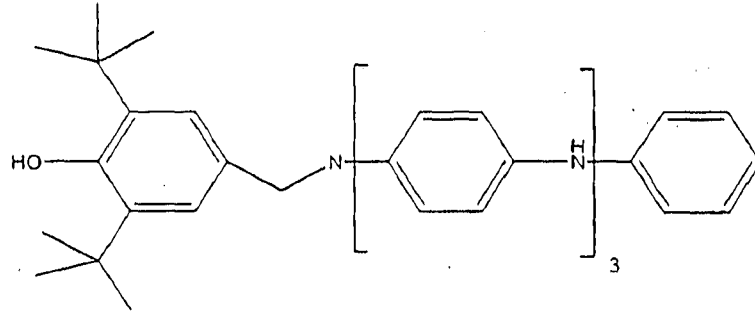

5

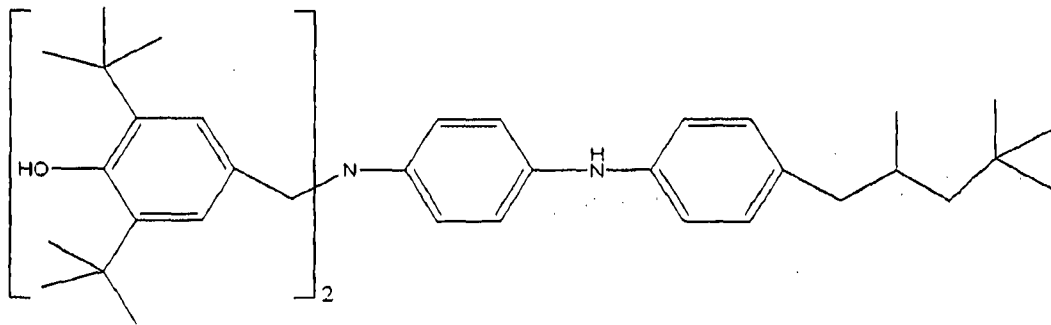
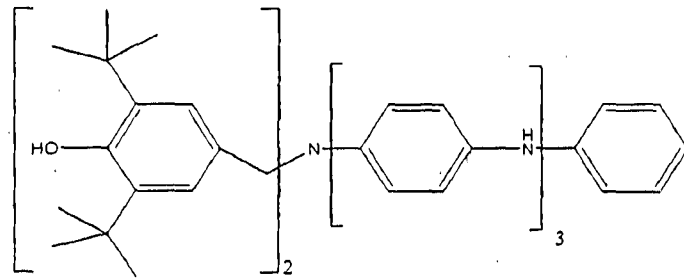

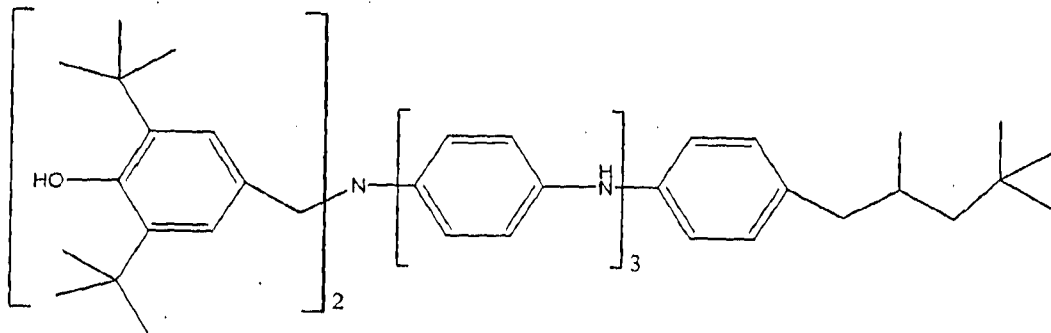
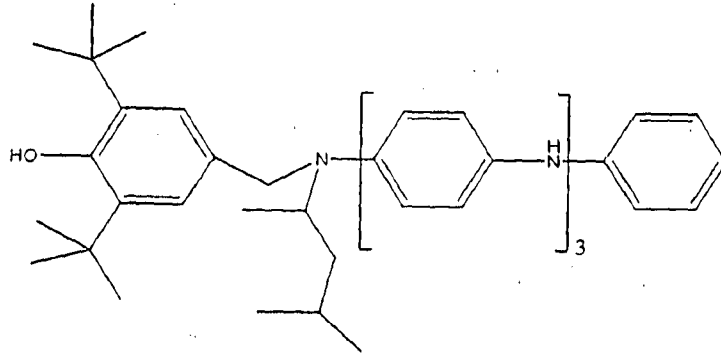
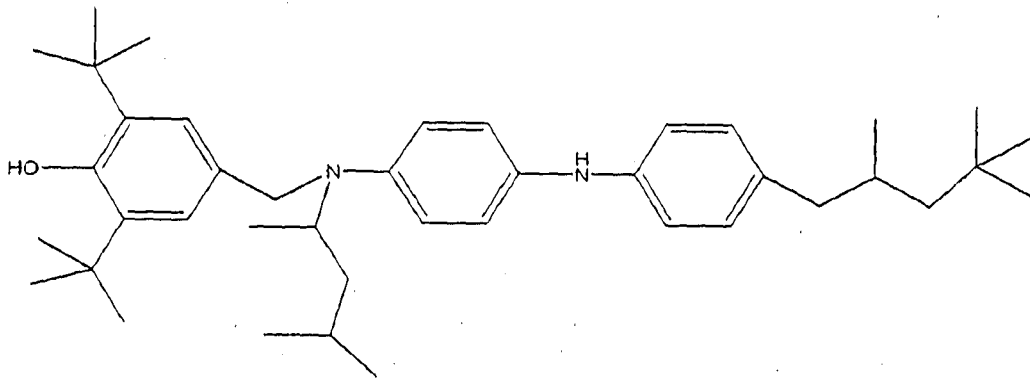
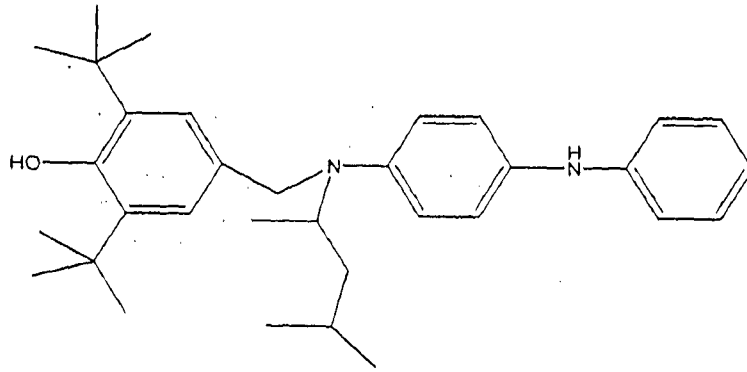

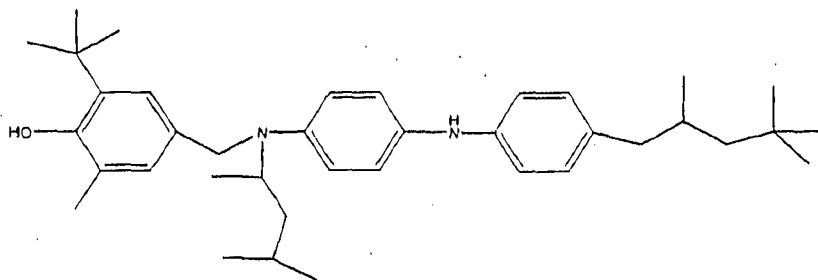
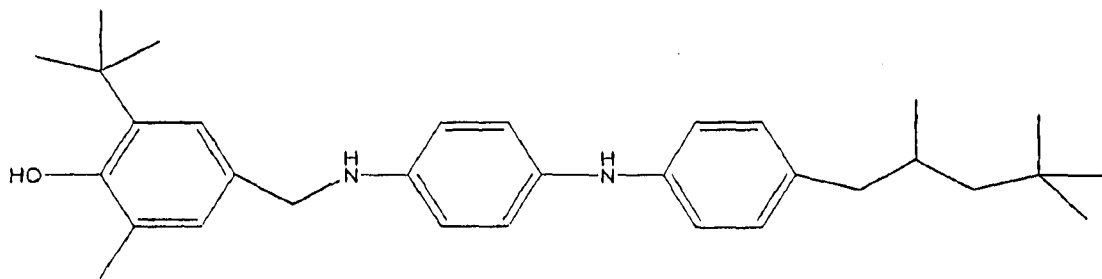
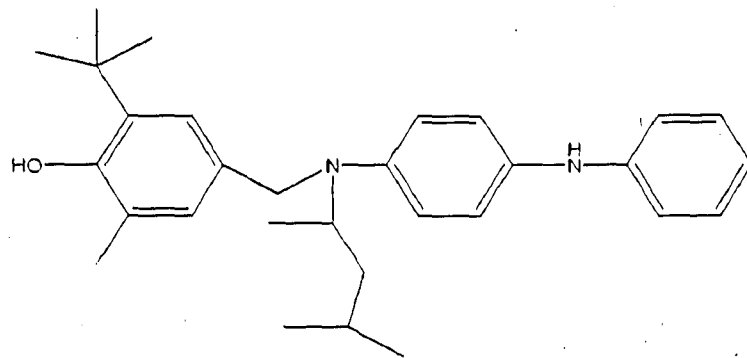
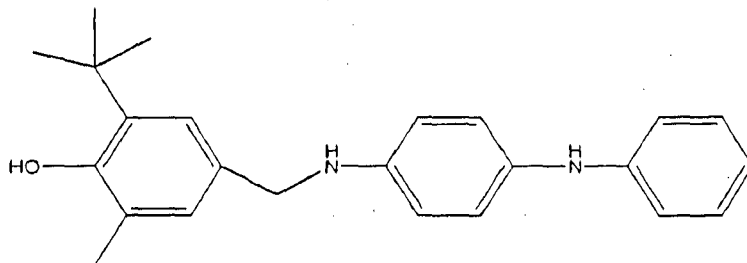
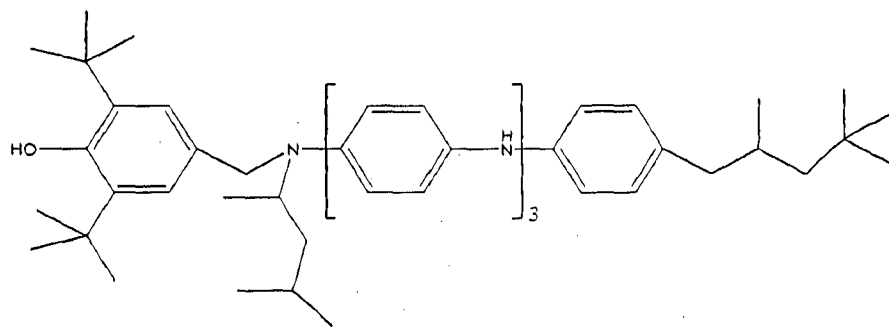

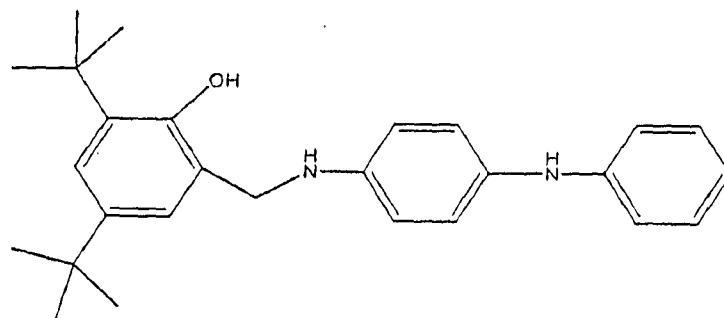
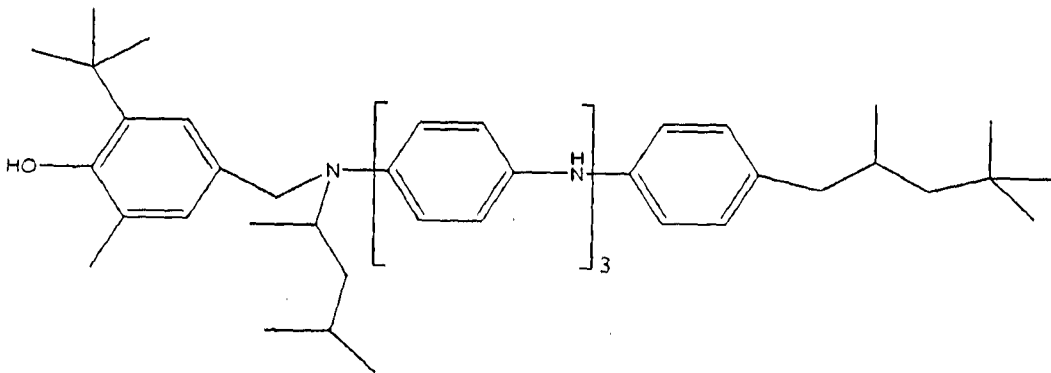
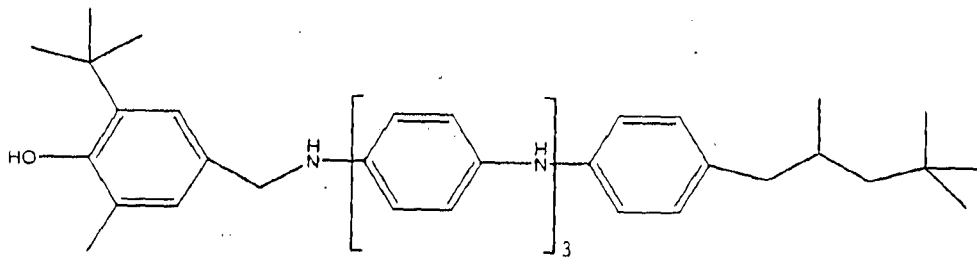
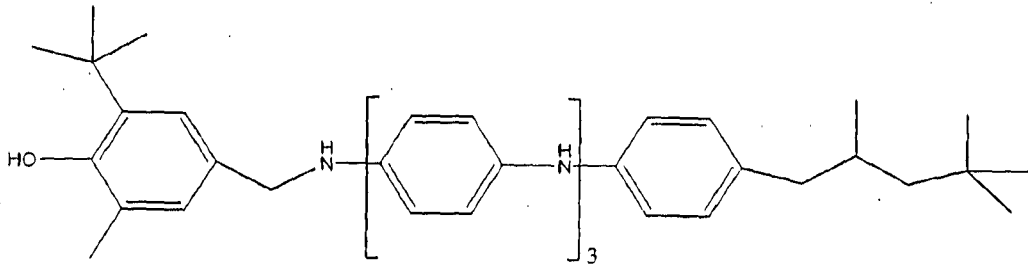
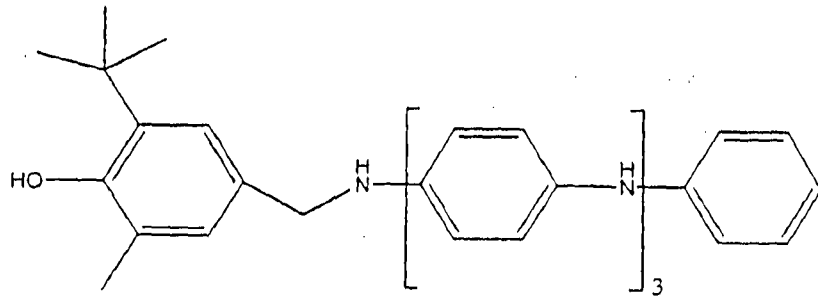

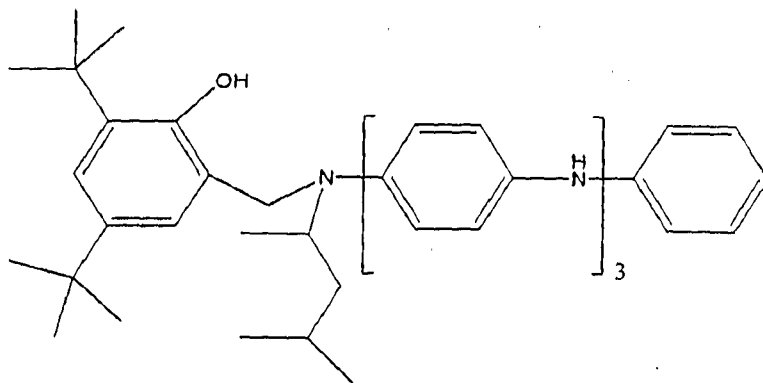
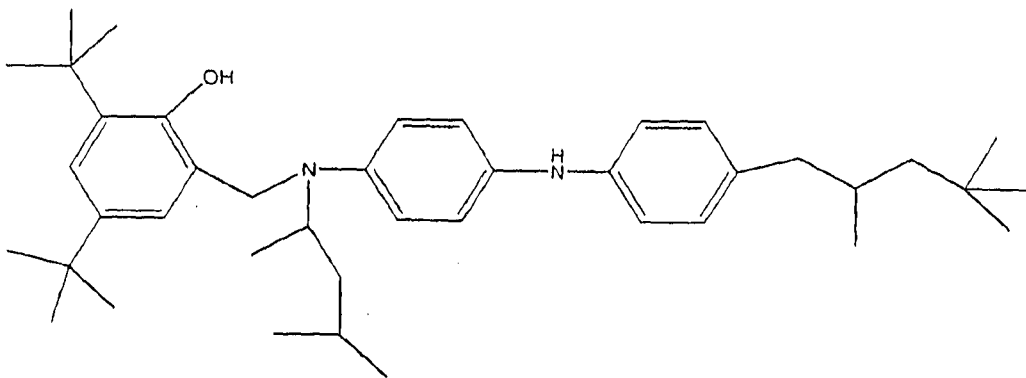
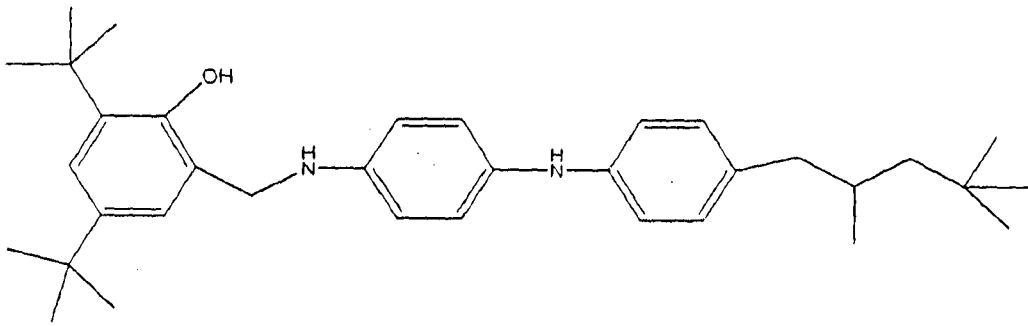
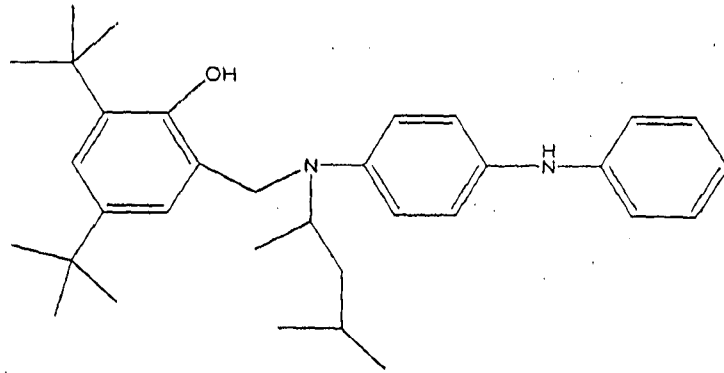

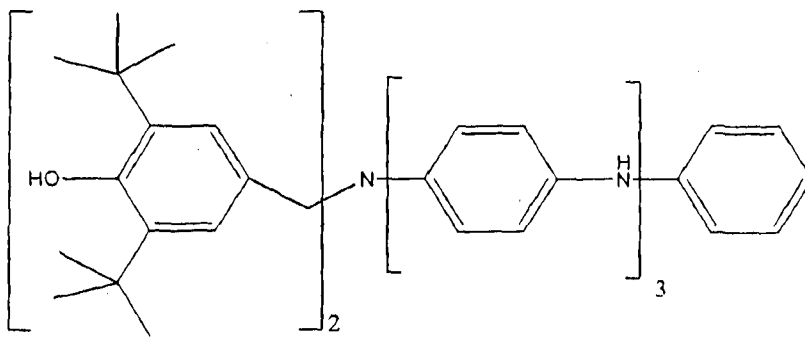
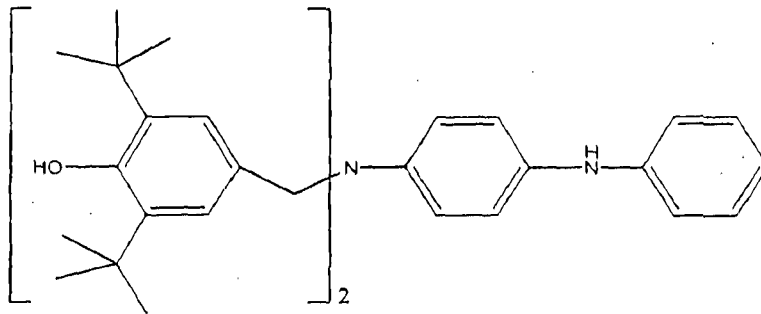
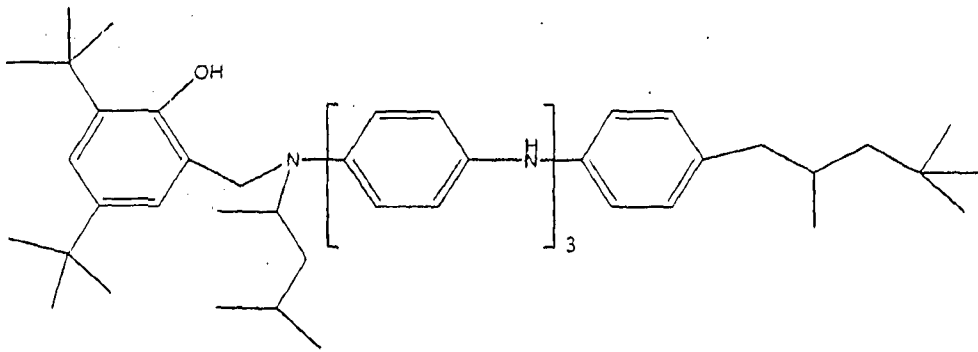
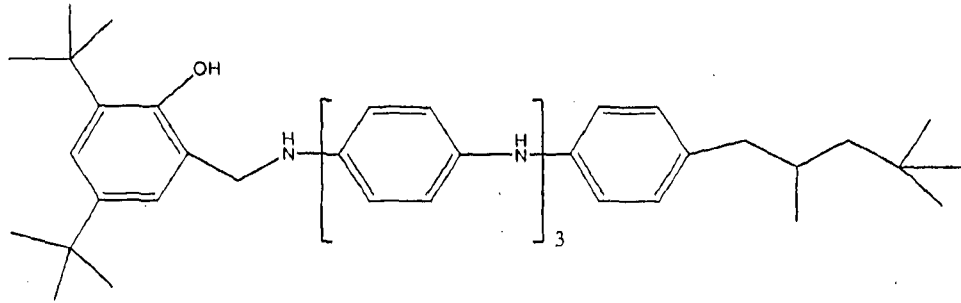

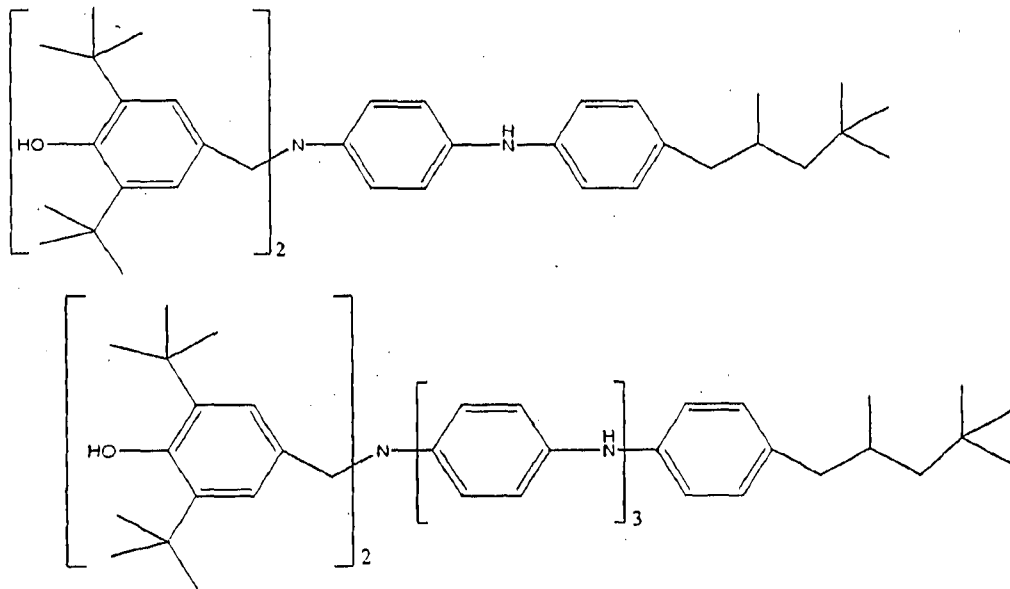

In another embodiment, the first antioxidants which are suitable for use in the compositions and methods of the present invention include alkylated antioxidant macromolecules having formula **K**:

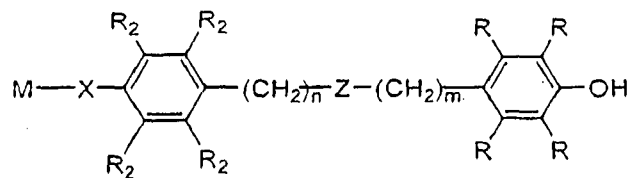

K

wherein, independently for each occurrence,

n and m are integers from 0 to 6, inclusive;

Z is -C(O)O-, -OC(O)-, -C(O)NH-, -NHC(O)-, -NH-, -CH=N-, -C(O)-, -O-, -S-, -C(O)OC(O)-, or a bond;

R is H, C₁₋₆ alkyl, -OH, -NH₂, -SH, aryl, aralkyl, or

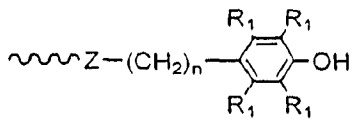

, wherein at least one R adjacent to the -OH group is a bulky alkyl group (e.g., butyl, *sec*-butyl, *tert*-butyl, 2-propyl, 1,1-dimethylhexyl, and the like);

- 77 -

R₁ is H, C₁₋₆ alkyl, aryl, alkylaryl, -OH, -NH₂, -SH, or C1-C6 alkyl ester wherein at least one R₁ adjacent to the -OH group is a bulky alkyl group (e.g., butyl, *sec*-butyl, *tert*-butyl, 2-propyl, 1,1-dimethylhexyl, and the like); and

R₂ is H, C₁₋₆ alkyl, aryl, aralkyl, -OH, -NH₂, or -SH wherein at least one R₁ adjacent to the -OH group is a bulky alkyl group (e.g., butyl, *sec*-butyl, *tert*-butyl, 2-propyl, 1,1-dimethylhexyl, and the like);

X is -C(O)O-, -OC(O)-, -C(O)NH-, -NHC(O)-, -NH-, -CH=N-, -C(O)-, -O-, -S-, -C(O)OC(O)-, or a bond;

M is H, aryl, C-1 to C-20 linear or branched alkyl chain with or without any functional group anywhere in the chain, or

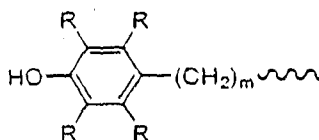

wherein m and each R is independently as described above;

wherein

R₂ is H, C₁₋₆ alkyl, -OH, -NH₂, -SH, aryl, ester, or

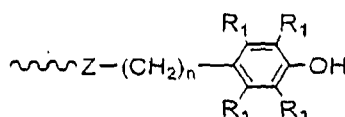

15

In certain embodiment, at least one R₂ is -OH and n, Z, and each R₁ are independently as described above.

In various embodiments, for compounds of formula **K**, Z is -OC(O)-. In another embodiment, Z is -C(O)O-. In another embodiment, Z is -C(O)NH-. In another embodiment, Z is -NHC(O)-. In another embodiment, Z is -NH-. In another embodiment, Z is -CH=N-. In another embodiment, Z is -C(O)-. In another embodiment, Z is -O-. In another embodiment, Z is -C(O)OC(O)-. In another embodiment, Z is a bond.

In another embodiment, for compounds of formula **K**, both R groups adjacent to -OH are bulky alkyl groups (e.g., butyl, *sec*-butyl, *tert*-butyl, 2-propyl,

25

1,1-dimethylhexyl, and the like). In another embodiment, both R groups are *tert*-butyl.

In another embodiment, for compounds of formula **K**, M is

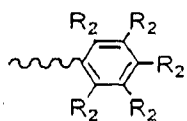

5 In another embodiment, for compounds of formula **K**, at least one R is

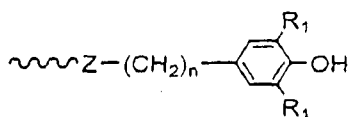

In another embodiment for compounds of formula **K**, n is 0.

In another embodiment, for compounds of formula **K**, m is 1.

In another embodiment, for compounds of formula **K**, n is 0 and m is 1.

10 In another embodiment, for compounds of formula **K**, n is 0, m is 1, and Z is -C(O)O-.

In another embodiment, for compounds of formula **K**, n is 0, m is 1, Z is -C(O)O-, and the two R groups adjacent to the OH are *tert*-butyl.

In another embodiment, for compounds of formula **K**, n is 0, m is 1, Z is

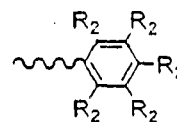

15 -C(O)O-, the two R groups adjacent to the OH are *t*-butyl, and M is

In another embodiment, for compounds of formula **K**, n is 0, m is 1, Z is -C(O)O-, the two R groups adjacent to the OH are *t*-butyl, M is

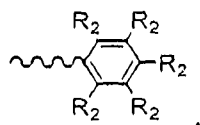

and the R₂ in the para position is OH.

In another embodiment, for compounds of formula **K**, *n* is 0, *m* is 1, *Z* is -C(O)O-, the two *R* groups adjacent to the OH are *t*-butyl, *M* is

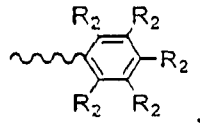

the R_2 in the para position is OH, and an adjacent R_2 is OH.

5 In another embodiment, for compounds of formula **K**, *n* is 0, *m* is 1, *Z* is -C(O)O-, the two *R* groups adjacent to the OH are *t*-butyl, *M* is

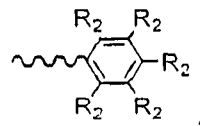

the R_2 in the para position is OH, and the two adjacent R_2 groups are -OH.

In one embodiment the antioxidant suitable for use in the compounds and methods of the present invention are compounds represented Structural Formula **K¹**:

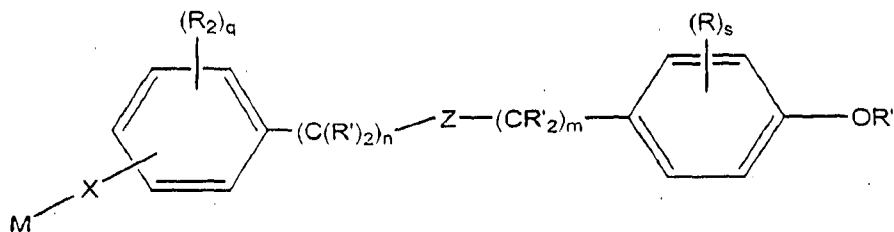

K¹

Z is -C(O)NR'-, -NR'C(O)-, -NR'-, -CR'=N-, -C(O)-, -C(O)O-, -OC(O)-, -O-, -S-, -C(O)OC(O)- or a bond. Each *R'* is independently -H or optionally substituted alkyl. Each *R* is independently an optionally substituted alkyl, optionally substituted aryl, optionally substituted alkoxy carbonyl, optionally substituted ester,

15 -OH, -NH₂, -SH, or

A benzene ring with substituents $(R_1)_u$ and OR' .

Each R_1 is independently an optionally substituted alkyl, optionally substituted aryl, optionally

substituted alkoxy carbonyl, optionally substituted ester, -OH, -NH₂ or -SH. Each R₂ is independently an optionally substituted alkyl, optionally substituted aryl, optionally substituted alkoxy carbonyl, optionally substituted ester, -OH, -NH₂ or -SH. X is -C(O)O-, -OC(O)-, -C(O)NR'-, -NR'C(O)-, -NR'-, -CH=N-, -C(O)-, -O-

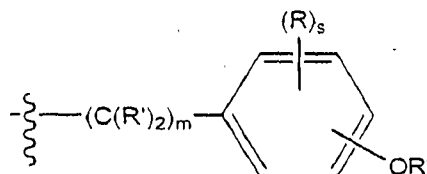

5 -S-, -NR'- or -C(O)OC(O)-. M is an alkyl or

Each n and m are independently integers from 0 to 6. Each s, q and u are independently integers from 0 to 4. In certain embodiments M is not

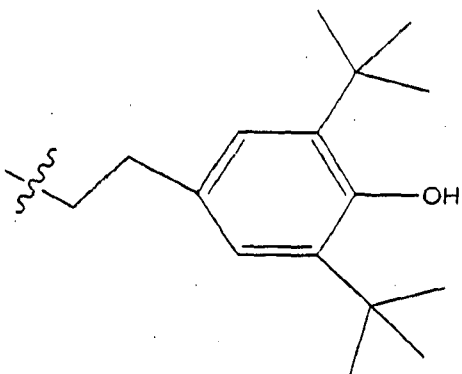

when X is -C(O)O- or -OC(O)-.

10 In certain embodiments for compounds represented by Structural Formula K¹:

Z is -C(O)NR'-, -NR'C(O)-, -NR'-, -CR'=N-, -C(O)-, -C(O)O-, -OC(O)-, -O-, -S-, -C(O)OC(O)- or a bond. In certain other embodiments Z is -C(O)O-, -OC(O)-, -C(O)NH-, -NHC(O)-, -NH-, -O- or -C(O)-. In certain other embodiments, Z is -C(O)NH- or -NHC(O)-. Optionally, Z is not -C(O)O-, -OC(O)-, -O- or -NH-. In various embodiments, the present invention relates to a compound of Structural Formula 1 and the attendant definitions, wherein Z is -OC(O)-. In another embodiment, Z is -C(O)O-. In another embodiment, Z is -C(O)NH-. In another embodiment, Z is -NHC(O)-. In another embodiment, Z is -NH-. In another embodiment, Z is -CH=N-. In another embodiment, Z is -C(O)-. In another embodiment, Z is -O-. In another embodiment, Z is -C(O)OC(O)-. In another embodiment, Z is a bond.

- 81 -

Each R' is independently -H or optionally substituted alkyl. In certain other embodiments R' is -H or an alkyl group. In certain other embodiments R' is -H or a C1-C10 alkyl group. In certain other embodiments R' is -H.

Each R is independently an optionally substituted alkyl, optionally substituted aryl, optionally substituted alkoxy carbonyl, optionally substituted ester,

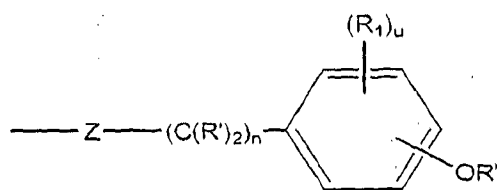

-OH, -NH₂, -SH, or . In certain other embodiments, each R is independently an optionally substituted alkyl or optionally substituted alkoxy carbonyl. In certain other embodiment each R is independently an alkyl or alkoxy carbonyl. In certain other embodiments each R is independently a C1-C6 alkyl or a C1-C6 alkoxy carbonyl. In certain other embodiments each R is independently *tert*-butyl or propoxy carbonyl. In certain other embodiments each R is independently an alkyl group. In certain embodiments each R is independently a bulky alkyl group. Suitable examples of bulky alkyl groups include butyl, *sec*-butyl, *tert*-butyl, 2-propyl, 1,1-dimethylhexyl, and the like. In certain embodiments each R is *tert*-butyl. In certain embodiments at least one R adjacent to the -OH group is a bulky alkyl group (e.g., butyl, *sec*-butyl, *tert*-butyl, 2-propyl, 1,1-dimethylhexyl, and the like). In certain other embodiments both R groups adjacent to -OH are bulky alkyl groups (e.g., butyl, *sec*-butyl, *tert*-butyl, 2-propyl, 1,1-dimethylhexyl, and the like). In another embodiment, both R groups are *tert*-butyl. In another embodiment, both R groups are *tert*-butyl adjacent to the OH group.

Each R₁ is independently an optionally substituted alkyl, optionally substituted aryl, optionally substituted alkoxy carbonyl, optionally substituted ester, -OH, -NH₂ or -SH. In certain other embodiments, each R₁ is independently an optionally substituted alkyl or optionally substituted alkoxy carbonyl. In certain other embodiment each R₁ is independently an alkyl or alkoxy carbonyl. In certain other embodiments each R₁ is independently a C1-C6 alkyl or a C1-C6 alkoxy carbonyl. In certain other embodiments each R₁ is independently *tert*-butyl or propoxy carbonyl. In certain other embodiments each R₁ is independently an alkyl

- 82 -

group. In certain embodiments each R_1 is independently a bulky alkyl group. Suitable examples of bulky alkyl groups include butyl, *sec*-butyl, *tert*-butyl, 2-propyl, 1,1-dimethylhexyl, and the like. In certain embodiments each R_1 is *tert*-butyl. In certain embodiments at least one R_1 adjacent to the -OH group is a bulky alkyl group (e.g., butyl, *sec*-butyl, *tert*-butyl, 2-propyl, 1,1-dimethylhexyl, and the like). In certain other embodiments both R_1 groups adjacent to -OH are bulky alkyl groups (e.g., butyl, *sec*-butyl, *tert*-butyl, 2-propyl, 1,1-dimethylhexyl, and the like). In another embodiment, both R_1 groups are *tert*-butyl. In another embodiment, both R_1 groups are *tert*-butyl adjacent to the OH group.

Each R_2 is independently an optionally substituted alkyl, optionally substituted aryl, optionally substituted alkoxy carbonyl, optionally substituted ester, -OH, -NH₂ or -SH. In certain other embodiments, each R_2 is independently an optionally substituted alkyl or optionally substituted alkoxy carbonyl. In certain other embodiment each R_2 is independently an alkyl or alkoxy carbonyl. In certain other embodiments, each R_2 is independently an optionally substituted alkyl. In certain other embodiment each R_2 is independently an alkyl. In certain other embodiments each R_2 is independently a C1-C10 alkyl. In certain other embodiments each R_2 is independently a C1-C6 alkyl. In certain other embodiments each R_2 is independently a bulky alkyl group or a straight chained alkyl group. In certain other embodiments each R_2 is independently methyl, ethyl, propyl, butyl, *sec*-butyl, *tert*-butyl, 2-propyl or 1,1-dimethylhexyl. In certain embodiments each R_2 is methyl or *tert*-butyl.

X is -C(O)O-, -OC(O)-, -C(O)NR'-, -NR'C(O)-, -NR'-, -CH=N-, -C(O)-, -O-, -S-, -NR'- or -C(O)OC(O)-. In certain embodiments X is -NH-, -S- or -O-. In certain embodiments X is -O-. Optionally X is a bond.

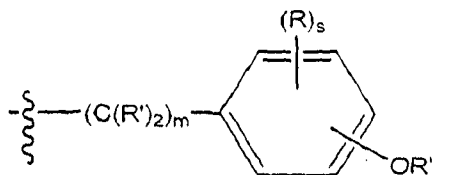

M is an alkyl or M is alkyl. In certain other embodiments M is a C1-C20 linear or branched chain

- 83 -

alkyl. In certain other embodiments M is a C5-C20 linear or branched chain alkyl. In certain other embodiments M is decane.

Each n and m are independently integers from 0 to 6. In certain embodiments each n and m are independently integers from 0 to 2.

5 In another embodiment, the antioxidant suitable for use in the compositions and methods of the present invention is represented by a compound of Structural Formula K^1 wherein n is 0.

In another embodiment, the antioxidant suitable for use in the compositions and methods of the present invention is represented by a compound of Structural
10 Formula K^1 wherein m is 1.

In another embodiment, the antioxidant suitable for use in the compositions and methods of the present invention is represented by a compound of Structural Formula K^1 and the attendant definitions, wherein n is 0 and m is 1.

In another embodiment, the antioxidant suitable for use in the compositions
15 and methods of the present invention is represented by a compound of Structural Formula K^1 wherein n is 0, m is 1, and Z is $-C(O)O-$.

In another embodiment, the antioxidant suitable for use in the compositions and methods of the present invention is represented by a compound of Structural
20 Formula K^1 wherein n is 0, m is 1, Z is $-C(O)O-$, and the two R groups adjacent to the OH are *tert*-butyl.

Each s, q and u are independently integers from 0 to 4. In certain embodiments, each s and q are independently integers from 0 to 2. In certain embodiments, s is 2.

In certain embodiments for compounds represented by Structural Formula K^1

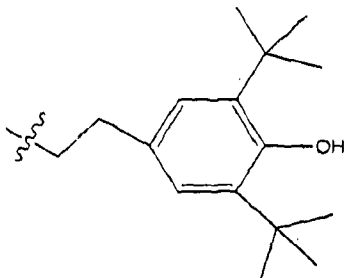

25 M is not

when X is $-C(O)O-$ or $-OC(O)-$.

In a sixth embodiment of the present invention directed to a compound represented by Structural Formula K¹, the compound is represented by a Structural Formula selected from:

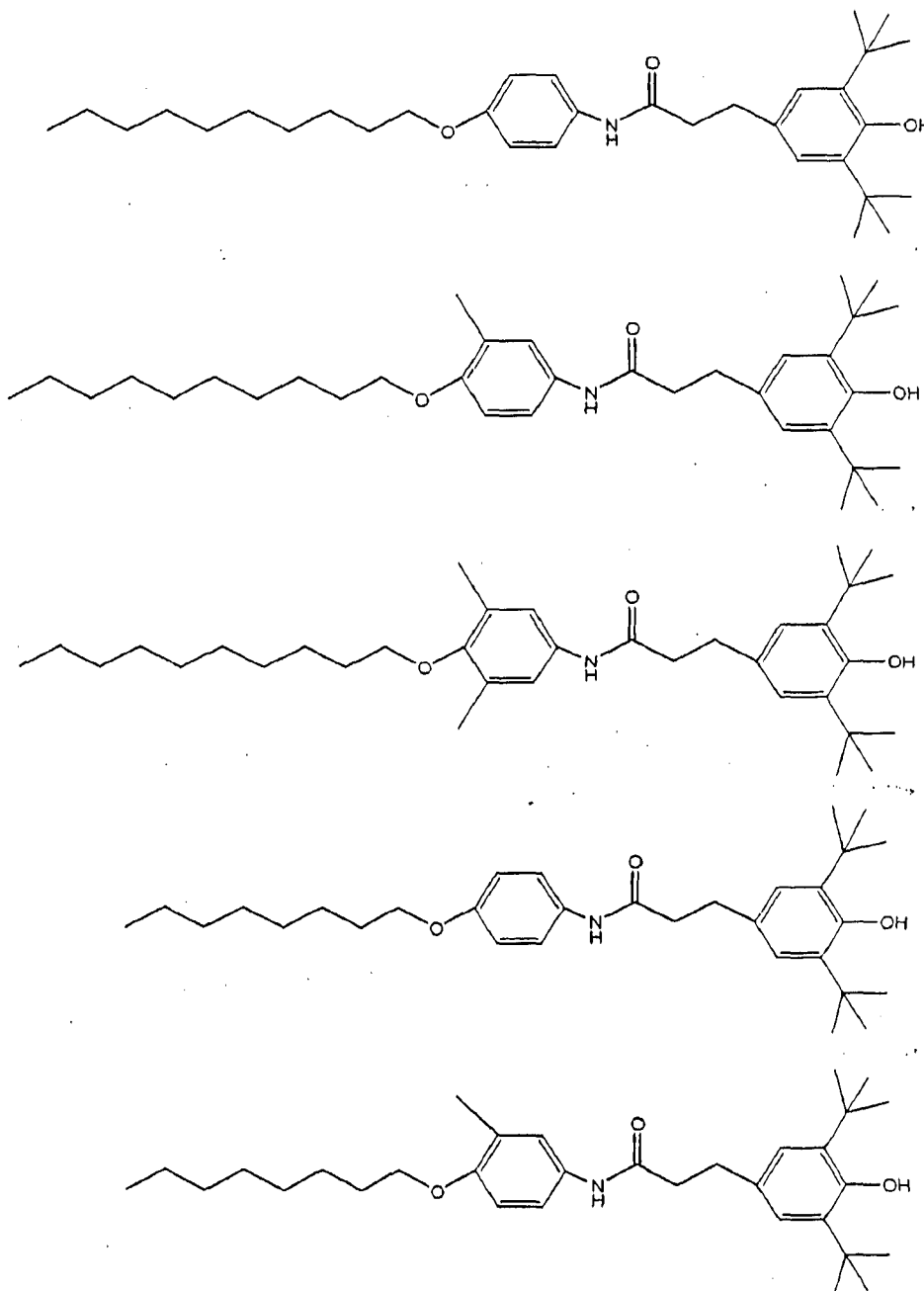

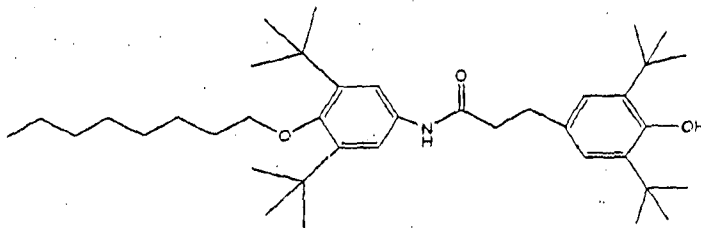
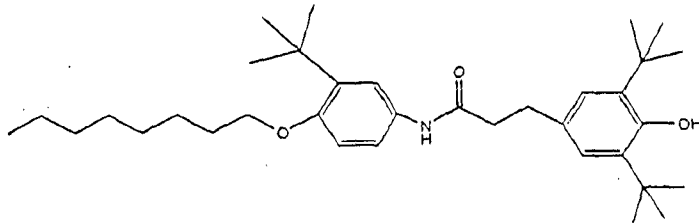
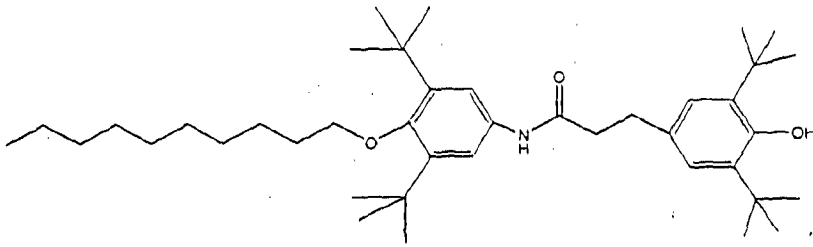
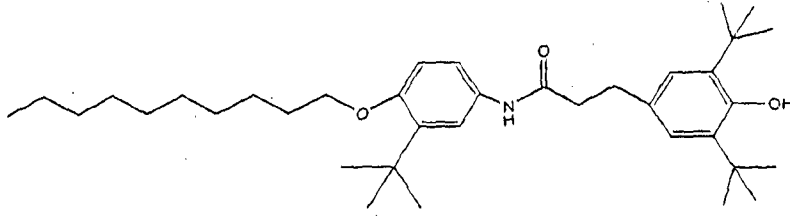

- 86 -

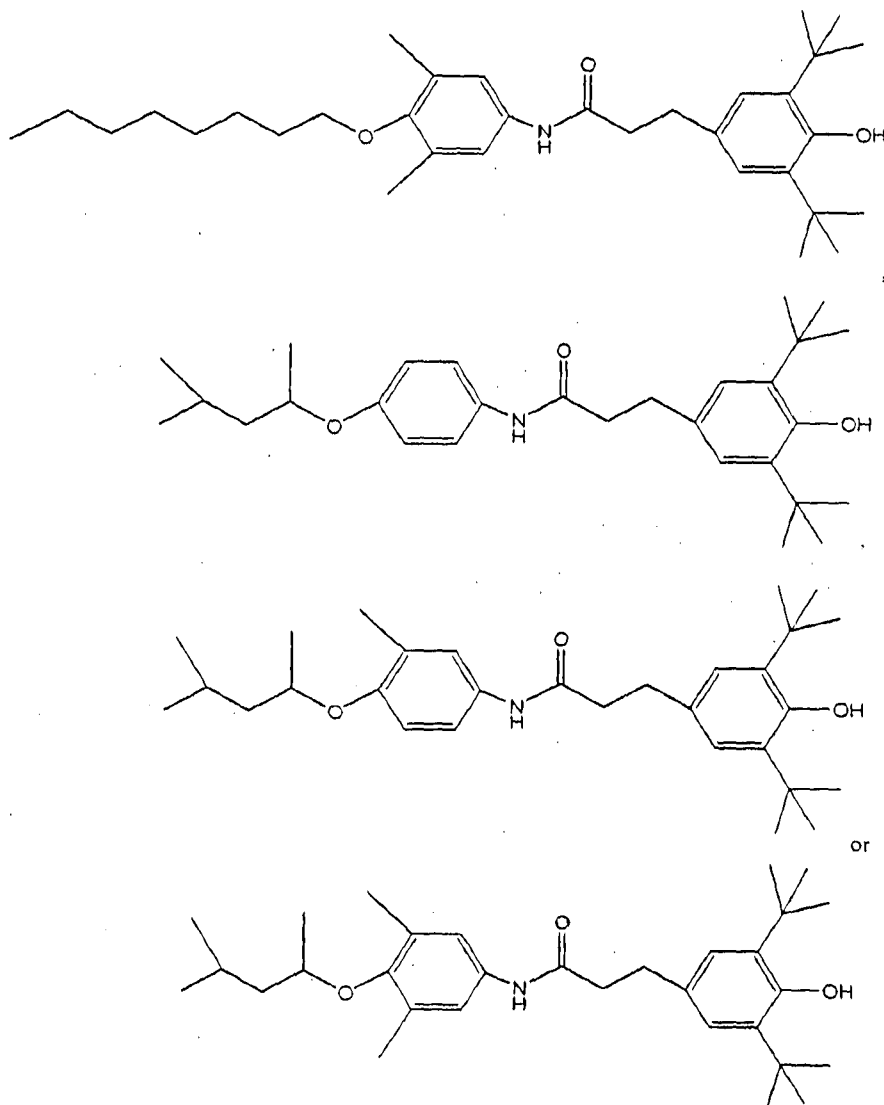

In another embodiment, the antioxidants which are suitable for use in the compositions and methods of the present invention include alkylated antioxidant macromolecules having formula **L**.

- 87 -

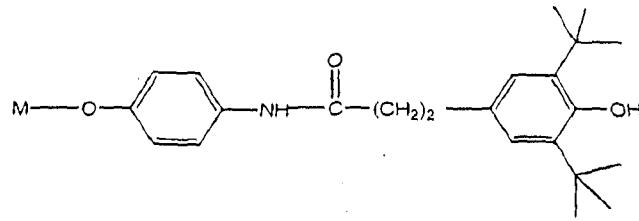

L

where M is C1 to C20- linear or branched alkyl chains.

In another embodiment the antioxidants which are suitable for use in the compositions and methods of the present invention are alkylated antioxidant

5 macromolecules having formula A:

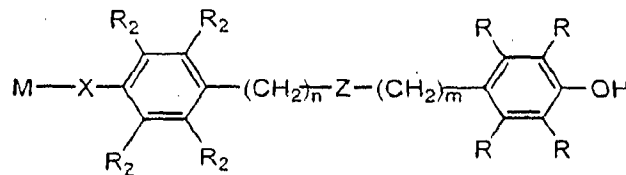

A

wherein, independently for each occurrence:

n and m are integers from 0 to 6, inclusive;

10 Z is -C(O)O-, -OC(O)-, -C(O)NH-, -NHC(O)-, -NH-, -CH=N-, -C(O)-, -O-, -S-, -C(O)OC(O)-, or a bond;

R is H, C₁₋₆ alkyl, -OH, -NH₂, -SH, aryl, ester, or

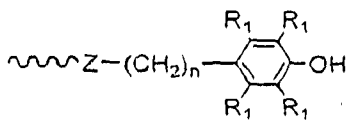

15 the like); wherein at least one R adjacent to the -OH group is a bulky alkyl group (e.g., butyl, *sec*-butyl, *tert*-butyl, 2-propyl, 1,1-dimethylhexyl, and the like);

R₁ is H, C₁₋₆ alkyl, aryl, aralkyl, -OH, -NH₂, -SH, or C₁-C₆ alkyl ester wherein at least one R₁ adjacent to the -OH group is a bulky alkyl group (e.g., butyl, *sec*-butyl, *tert*-butyl, 2-propyl, 1,1-dimethylhexyl, and the like); and

- 88 -

R₂ is H, C₁₋₆ alkyl, aryl, aralkyl, -OH, -NH₂, -SH, or ester, wherein at least one R₁ adjacent to the -OH group is a bulky alkyl group (e.g., butyl, *sec*-butyl, *tert*-butyl, 2-propyl, 1,1-dimethylhexyl, and the like);

X is -C(O)O-, -OC(O)-, -C(O)NH-, -NHC(O)-, -NH-, -CH=N-, -C(O)-, -O-,
5 -S-, -C(O)OC(O)-, or a bond;

M is H, aryl, C-1 to C-20 linear or branched alkyl chain with or without any

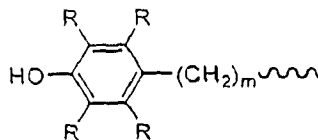

functional group anywhere in the chain, or

In one embodiment, the first antioxidants which are suitable for use in the compositions and methods of the present invention are sterically hindered phenol
10 and phosphite based compounds, represented by a formula selected from I-III:

Specific examples of compounds which are suitable for use in the compositions and methods of the present invention are represented by one of the following structural formulas:

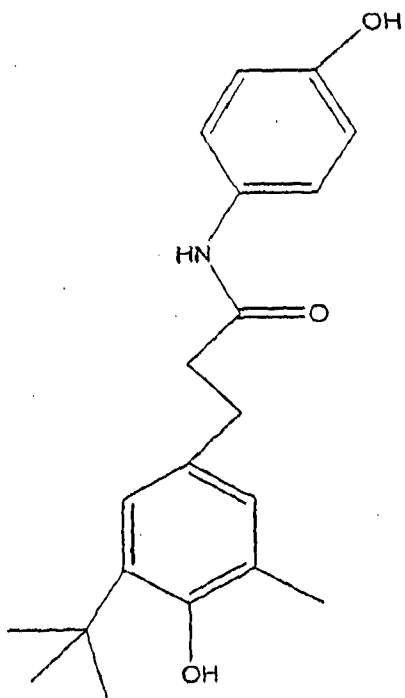
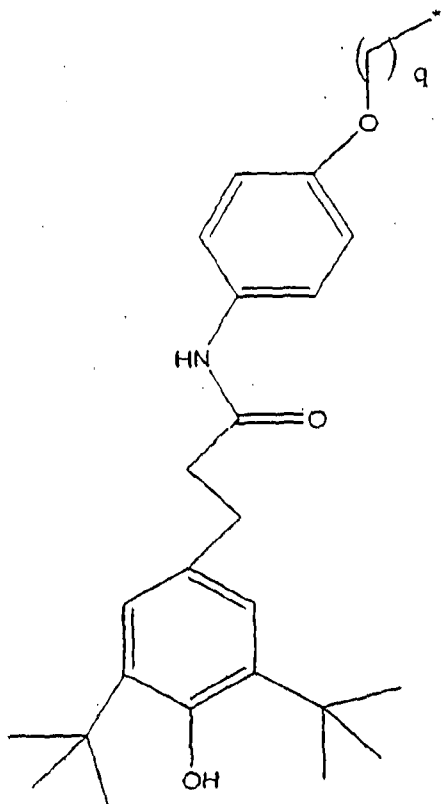

and

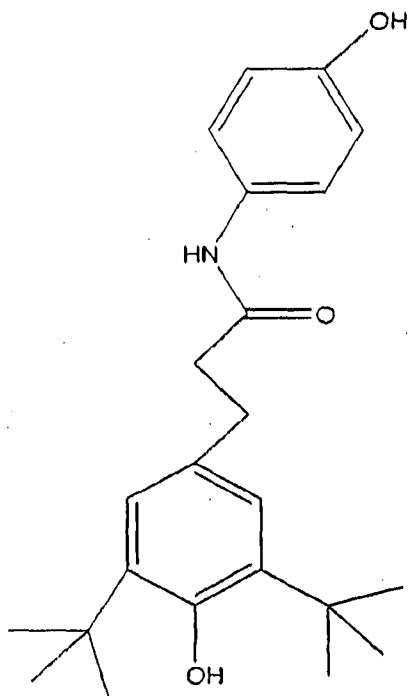

In one embodiment, the first antioxidants which are suitable for use in the compositions and methods of the present invention are sterically hindered phenol and phosphate based compounds, represented by a formula selected from O, P and

5 Q.

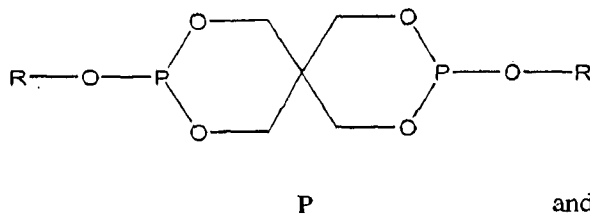
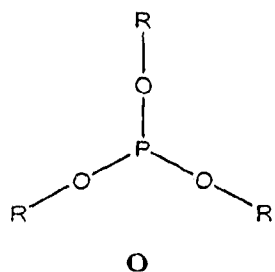

and

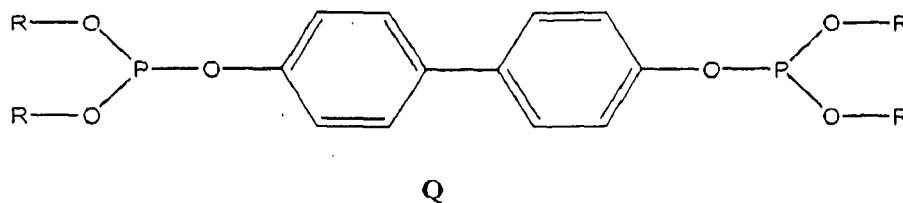

R is:

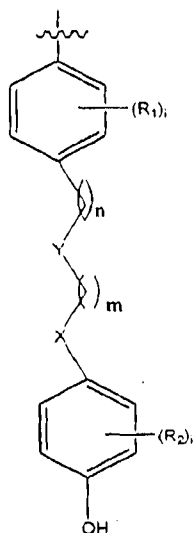

or

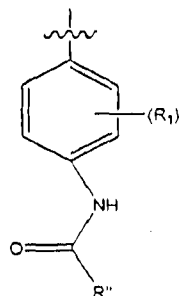

R_1 and R_2 in each occurrence, independently is an optionally substituted alkyl, optionally substituted aryl or optionally substituted aralkyl. In one embodiment, each R_1 and R_2 are independently an optionally substituted alkyl. In another embodiment, each R_1 and R_2 are independently a linear or branched C1-C6 alkyl.

In one embodiment R is:

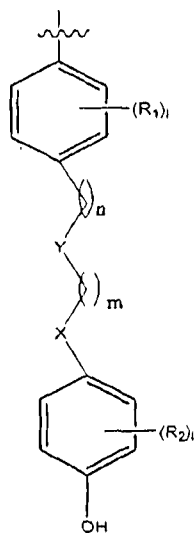

In another embodiment R is:

- 92 -

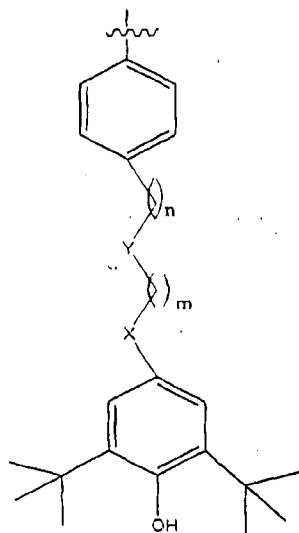

In yet another embodiment R is:

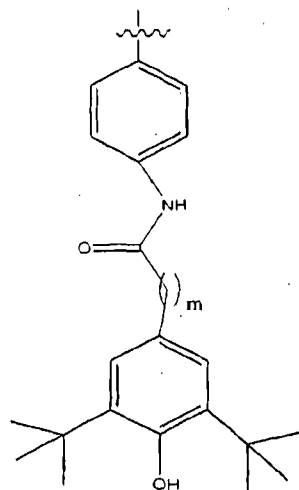

X and Y in each occurrence independently is a bond, -O-, -NH-, -C(O)NH-,
 5 -NHC(O)-, -C(O)O-, -OC(O)- or -CH₂-. In one embodiment, X and Y in each
 occurrence independently is a bond or -CH₂-. In another embodiment, X and Y in
 each occurrence independently is a bond, -O- or -CH₂-. In yet another embodiment,
 X and Y in each occurrence independently is a bond, -NH- or -CH₂-. In yet another
 embodiment, X and Y in each occurrence independently is a bond, -C(O)NH- or -
 10 CH₂-. In yet another embodiment, X and Y in each occurrence independently is a
 bond, -NHC(O)-, or -CH₂-. In yet another embodiment, X and Y in each occurrence

- 93 -

independently is a bond, -C(O)O- or -CH₂-. In yet another embodiment, X and Y in each occurrence independently is a bond, -OC(O)- or -CH₂-.

n and m in each occurrence independently is 0 or a positive integer. In one embodiment, n and m in each occurrence independently is 0 to 18. In another embodiment, n and m in each occurrence independently is 0 to 12. In yet another embodiment, n and m are in each occurrence independently is 0 to 6.

i and j in each occurrence independently is 0, 1, 2, 3 or 4. In one embodiment i and j in each occurrence independently is 0, 1 or 2. In a particular embodiment, i is 0. In another particular embodiment j is 2.

10 R'' is an optionally substituted alkyl. In one embodiment R'' is C1-C6 alkyl.

In a particular embodiment, for compounds represented by structural formulas **O**, **P** and **Q**, R is:

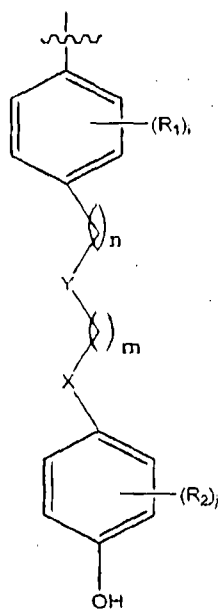

15 and n and m in each occurrence independently is 0 to 12, and the remainder of the variables are as described above for structural formulas **O**, **P** and **Q**.

In another particular embodiment, for compounds represented by structural formulas **O**, **P** and **Q**, R, n and m are as described immediately above, and R₁ and R₂ in each occurrence, independently is an optionally substituted alkyl; i and j in

- 94 -

each occurrence independently is 0, 1 or 2; and the remainder of the variables are as described above for structural formulas **O**, **P** and **Q**.

In yet another particular embodiment, for compounds represented by structural formulas **O**, **P** and **Q**, R_1 , R_2 , i and j are as described immediately above, and R is:

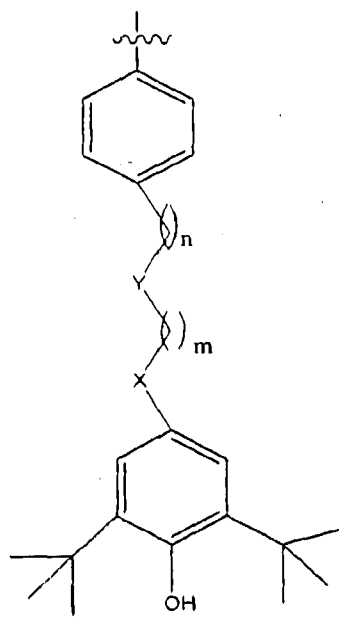

n and m in each occurrence, independently is 0 to 6; and the remainder of the variables are as described above for structural formulas **O**, **P** and **Q**.

In another particular embodiment, for compounds represented by structural formulas **O**, **P** and **Q**, R_1 , R_2 , i , j , R , n and m are as described immediately above, and X and Y in each occurrence, independently is a bond or $-\text{CH}_2-$; and the remainder of the variables are as described above for structural formulas **O**, **P** and **Q**.

In another particular embodiment, for compounds represented by structural formulas **O**, **P** and **Q**, R_1 , R_2 , i , j , R , n and m are as described immediately above, and X and Y in each occurrence, independently is a bond, $-\text{O}-$ or $-\text{CH}_2-$; and the remainder of the variables are as described above for structural formulas **O**, **P** and **Q**.

In another particular embodiment, for compounds represented by structural formulas **O**, **P** and **Q**, R_1 , R_2 , i , j , R , n and m are as described immediately above,

- 95 -

and X and Y in each occurrence, independently is a bond, -NH- or -CH₂-; and the remainder of the variables are as described above for structural formulas **O**, **P** and **Q**.

In another particular embodiment, for compounds represented by structural formulas **O**, **P** and **Q**, R₁, R₂, i, j, R, n and m are as described immediately above, and X and Y in each occurrence, independently is a bond, -C(O)NH- or -CH₂-; and the remainder of the variables are as described above for structural formulas **O**, **P** and **Q**.

In another particular embodiment, for compounds represented by structural formulas **O**, **P** and **Q**, R₁, R₂, i, j, R, n and m are as described immediately above, and X and Y in each occurrence, independently is a bond, -NHC(O)-, or -CH₂-; and the remainder of the variables are as described above for structural formulas **O**, **P** and **Q**.

In another particular embodiment, for compounds of the present invention represented by structural formulas **O**, **P** and **Q**, R₁, R₂, i, j, R, n and m are as described immediately above, and X and Y in each occurrence, independently is a bond, -C(O)O- or -CH₂-; and the remainder of the variables are as described above for structural formulas **O**, **P** and **Q**.

In another particular embodiment, for compounds of the present invention represented by structural formulas **O**, **P** and **Q**, R₁, R₂, i, j, R, n and m are as described immediately above, and X and Y in each occurrence, independently is a bond, -OC(O)- or -CH₂-; and the remainder of the variables are as described above for structural formulas **O**, **P** and **Q**.

In an additional embodiment, for formulas **O**, **P** and **Q** R is:

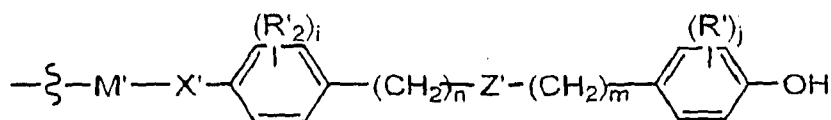

25

n and m in each occurrence, independently is 0 or a positive integer. In one embodiment, n and m in each occurrence, independently is 0 to 18. In another embodiment, n and m in each occurrence, independently is 0 to 12. In yet another embodiment, n and m in each occurrence, independently is 0 to 6.

- 96 -

i and j in each occurrence, independently is 0, 1, 2, 3 or 4. In one embodiment, i and j in each occurrence, independently is 0, 1 or 2. In a particular embodiment, i is 0. In another particular embodiment, j is 2.

Z' is -C(O)O-, -OC(O)-, -C(O)NH-, -NHC(O)-, -NH-, -CH=N-, -C(O)-, -O-,
 5 -S-, -C(O)OC(O)- or a bond. In one embodiment, Z' is -C(O)O-. In another embodiment, Z' is -OC(O)-. In yet another embodiment, Z' is -C(O)NH-. In yet another embodiment, Z' is -NHC(O)-. In yet another embodiment, Z' is -NH-. In yet another embodiment, Z' is -CH=N-. In yet another embodiment, Z' is -C(O)-. In yet another embodiment, Z' is -O-. In yet another embodiment, Z' is -S-. In yet
 10 another embodiment, Z' is -C(O)OC(O)-. In yet another embodiment, Z' is a bond.

R' is an optionally substituted C1-C6 alkyl, -OH, -NH₂, -SH, an optionally substituted aryl, an ester or

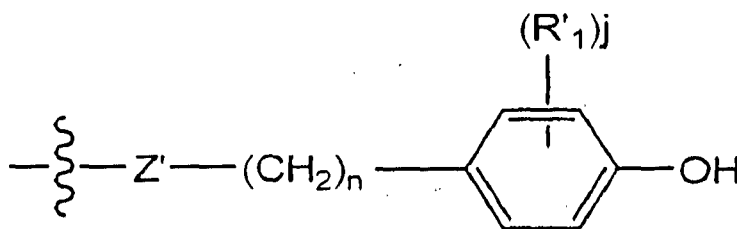

wherein at least one R' adjacent to the -OH group is an optionally substituted
 15 bulky alkyl group (e.g., butyl, *sec*-butyl, *tert*-butyl, 2-propyl, 1,1-dimethylhexyl, and the like).

R'₁ is an optionally substituted C1-C6 alkyl, an optionally substituted aryl, an optionally substituted aralkyl, -OH, -NH₂, -SH, or C1-C6 alkyl ester wherein at least one R₁ adjacent to the -OH group is a bulky alkyl group (e.g., butyl, *sec*-butyl,
 20 *tert*-butyl, 2-propyl, 1,1-dimethylhexyl, and the like).).

R'₂ is an optionally substituted C1-C6 alkyl, an optionally substituted aryl, an optionally substituted aralkyl, -OH, -NH₂, -SH, or ester.

X' is -C(O)O-, -OC(O)-, -C(O)NH-, -NHC(O)-, -NH-, -CH=N-, -C(O)-, -O-,
 25 -S-, -C(O)OC(O)- or a bond. In one embodiment X' is -C(O)O-. In another embodiment X' is -OC(O)-. In yet another embodiment X' is -C(O)NH-. In yet another embodiment X' is -NHC(O)-. In yet another embodiment X' is -NH-. In

yet another embodiment X' is -CH=N-. In yet another embodiment X' is -C(O)-. In yet another embodiment X' is -O-. In yet another embodiment X' is -S-. In yet another embodiment X' is -C(O)OC(O)-. In yet another embodiment X' is a bond.

M' is H, an optionally substituted aryl, an optionally substituted C1-C20 linear or branched alkyl chain with or without any functional group anywhere in the chain, or

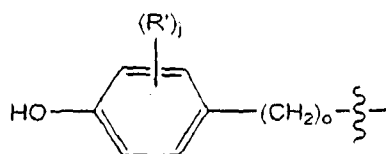

o is 0 or a positive integer. Preferably o is 0 to 18. More preferably o is 0 to 12. Even more preferably o is 0 to 6.

10 In yet another embodiment, for formulas O, P and Q R is:

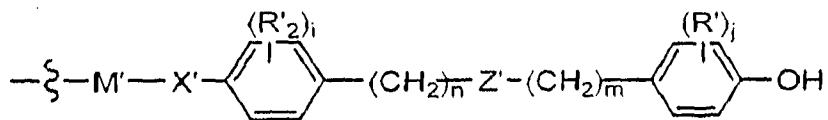

R'2 is C1-C6 alkyl, -OH, -NH2, -SH, aryl, ester, aralkyl or

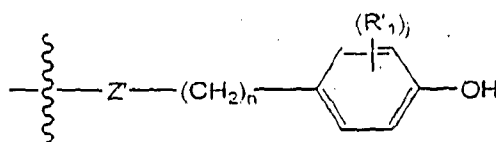

15 wherein at least one R'2 is -OH, and the values and preferred values for the remainder of the variables for R are as described immediately above.

In yet another embodiment, the present invention relates to a compound of formula O, P and Q, wherein M is

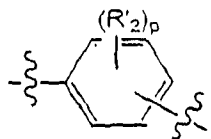

20 Wherein p is 0, 1, 2, 3 or 4; and the values and preferred values for the remainder of the variables are as described above for formulas O, P and Q.

Specific examples of compounds which are suitable for use in the compositions and methods of the present invention are represented by one of the following structural formulas:

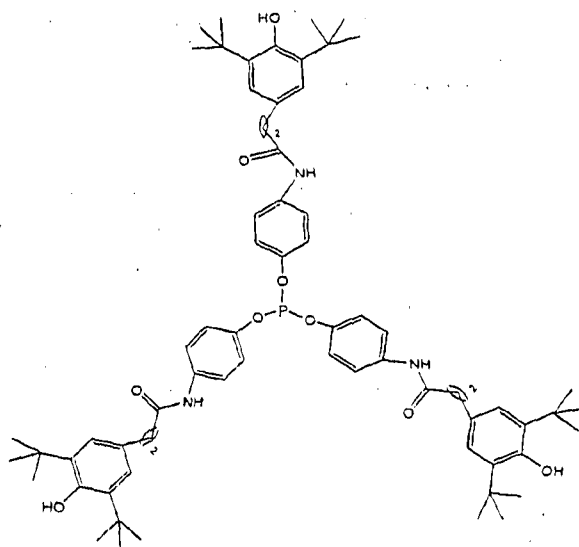

5

and

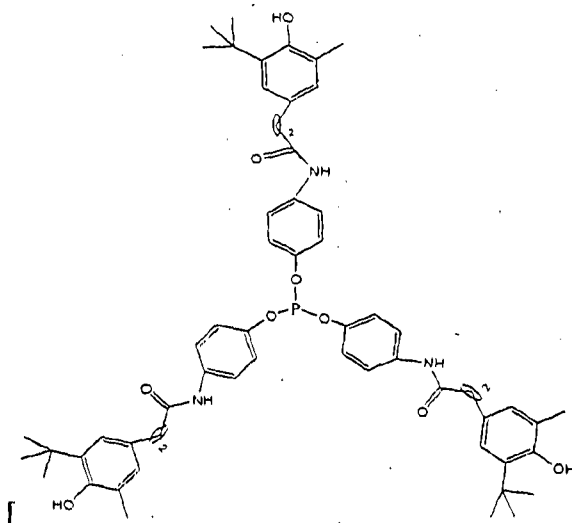

In another embodiment, the first antioxidants which are suitable for use in the compositions and methods of the present invention are represented by a structural formula selected from 1-6:

10

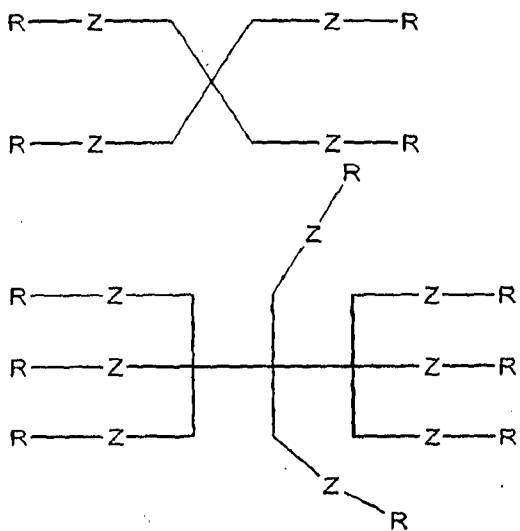

1

5

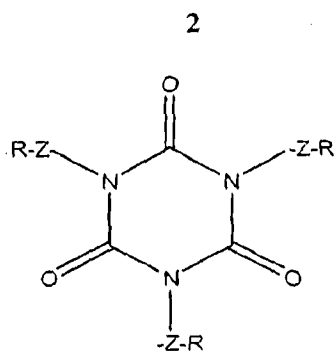

2

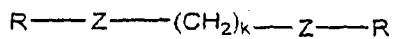

3

4

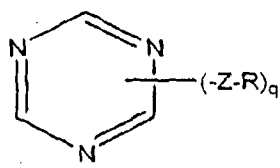

5

10

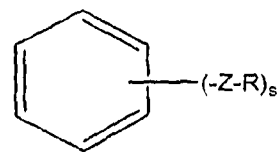

6

and

R is:

- 100 -

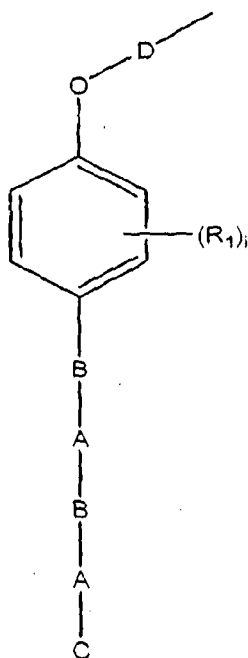

A in each occurrence, independently is a bond, -O-, -NH-, -S-, -C(O)-, -C(O)NH-, -NHC(O)-, -C(O)O-, -OC(O)-, -CH=N- or -N=CH-. In certain particular
 5 embodiments, A in each occurrence, independently is -C(O)NH- or -NHC(O)-.

B in each occurrence, independently is a bond or an optionally substituted alkylene group. In certain particular embodiments B is a C1-C6 alkyl.

C in each occurrence, independently is -H, an optionally substituted alkyl group or

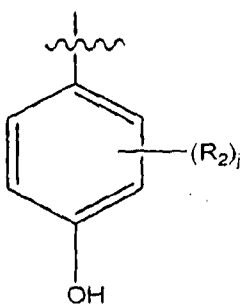

10

In a particular embodiment, C is:

- 101 -

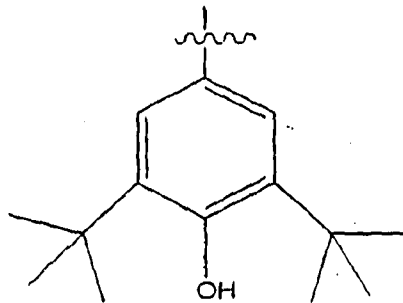

In a particular embodiment R is:

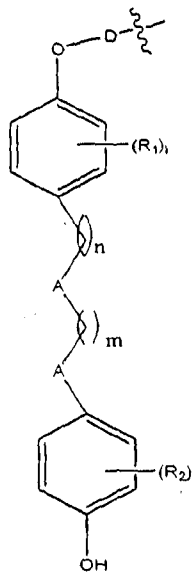

In another particular embodiment R is:

- 102 -

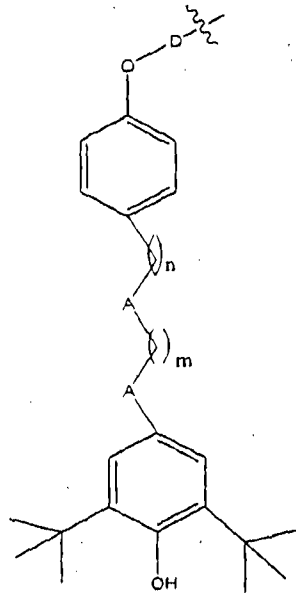

In yet another particular embodiment R is:

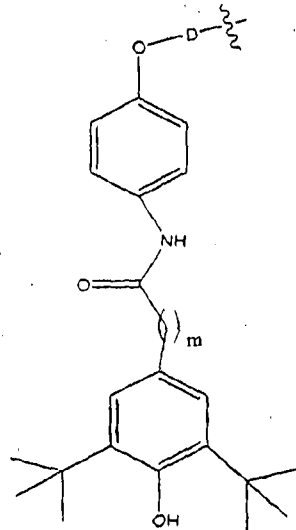

R₁ and R₂ in each occurrence, independently is an optionally substituted
 5 alkyl, optionally substituted aryl or optionally substituted aralkyl. In one
 embodiment, each R₁ and R₂ in each occurrence, independently is an optionally
 substituted alkyl. In another embodiment, each R₁ and R₂ in each occurrence,
 independently is a C1-C6 alkyl.

D in each occurrence, independently is a bond, an optionally substituted
 10 alkylene group, -(CH₂)_lC(O)O(CH₂)_l-, -(CH₂)_lNHC(O)(CH₂)_l-, -

- 103 -

$(\text{CH}_2)_i\text{C}(\text{O})\text{NH}(\text{CH}_2)_{i-}$, $-(\text{CH}_2)_i\text{C}(\text{O})\text{O}(\text{CH}_2)_{i-}$, $-(\text{CH}_2)_i\text{OC}(\text{O})(\text{CH}_2)_{i-}$, -
 $(\text{CH}_2)_i\text{CH}=\text{N}(\text{CH}_2)_{i-}$, $-(\text{CH}_2)_i\text{N}=\text{CH}(\text{CH}_2)_{i-}$, $-(\text{CH}_2)_i\text{NH}(\text{CH}_2)_{i-}$, $-(\text{CH}_2)_i\text{S}-(\text{CH}_2)_{i-}$, -
 $(\text{CH}_2)_i\text{O}(\text{CH}_2)_{i-}$ or $-(\text{CH}_2)_i\text{C}(\text{O})(\text{CH}_2)_{i-}$.

5 Z in each occurrence, independently is a bond, an optionally substituted alkylene group, -S-, -O- or -NH-.

i and j in each occurrence, independently is 0, 1, 2, 3 or 4. In one embodiment i and j in each occurrence, independently is 0, 1 or 2. In a particular embodiment, i is 0. In another particular embodiment, j is 2.

10 k is a positive integer from 1 to 20. In one embodiment, k is a positive integer from 1 to 12. In another embodiment, k is a positive integer from 1 to 6.

l is 0 or a positive integer from 1 to 20. In one embodiment, l is 0 or a positive integer from 1 to 12. In another embodiment, l is 0 or a positive integer from 1 to 6.

15 n and m in each occurrence independently is 0 or a positive integer. In one embodiment, n and m in each occurrence independently is 0 to 18. In another embodiment, n and m in each occurrence independently is 0 to 12. In yet another embodiment, n and m are in each occurrence independently is 0 to 6.

s is a positive integer from 1 to 6.

q is a positive integer from 1 to 3.

20 D in each occurrence, independently is a bond, an optionally substituted alkylene group, $-(\text{CH}_2)_i\text{C}(\text{O})\text{O}(\text{CH}_2)_{h-}$, $-(\text{CH}_2)_i\text{NHC}(\text{O})(\text{CH}_2)_{h-}$, -
 $(\text{CH}_2)_i\text{C}(\text{O})\text{NH}(\text{CH}_2)_{h-}$, $-(\text{CH}_2)_i\text{C}(\text{O})\text{O}(\text{CH}_2)_{h-}$, $-(\text{CH}_2)_i\text{OC}(\text{O})(\text{CH}_2)_{h-}$, -
 $(\text{CH}_2)_i\text{CH}=\text{N}(\text{CH}_2)_{h-}$, $-(\text{CH}_2)_i\text{N}=\text{CH}(\text{CH}_2)_{h-}$, $-(\text{CH}_2)_i\text{NH}(\text{CH}_2)_{h-}$, $-(\text{CH}_2)_i\text{S}-(\text{CH}_2)_{h-}$, -
 $(\text{CH}_2)_i\text{O}(\text{CH}_2)_{h-}$ or $-(\text{CH}_2)_i\text{C}(\text{O})(\text{CH}_2)_{h-}$.

25 Z in each occurrence, independently is a bond, an optionally substituted alkylene group, -S-, -O- or -NH-. In a particular embodiment, Z is a single bond.

i and j in each occurrence, independently is 0, 1, 2, 3 or 4. In one embodiment i and j in each occurrence, independently is 0, 1 or 2. In a particular embodiment, i is 0. In another particular embodiment, j is 2.

k is a positive integer from 1 to 20. In one embodiment, k is a positive integer from 1 to 12. In another embodiment, k is a positive integer from 1 to 6.

l is 0 or a positive integer from 1 to 20, and when D is $-(CH_2)_l$ NHC(O)(CH₂)_h-, $-(CH_2)_l$ OC(O)(CH₂)_h-, $-(CH_2)_l$ S-(CH₂)_h-, or $-(CH_2)_l$ O(CH₂)_h-, l is not 0. In one embodiment, l is 0 or a positive integer from 1 to 12. In another embodiment, l is 0 or a positive integer from 1 to 6.

h is 0 or a positive integer from 1 to 20, When Z is not a bond and D is $-(CH_2)_h$ C(O)O(CH₂)_h-, $-(CH_2)_h$ C(O)NH(CH₂)_h-, $-(CH_2)_h$ C(O)O(CH₂)_h-, $-(CH_2)_h$ NH(CH₂)_h-, $-(CH_2)_h$ S-(CH₂)_h-, or $-(CH_2)_h$ O(CH₂)_h-, h is not 0. In one embodiment, h is 0 or a positive integer from 1 to 12. In another embodiment, h is 0 or a positive integer from 1 to 6. In another embodiment, h is 0.

In certain other embodiments R is:

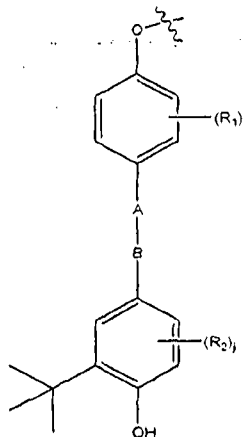

15 R₁ and R₂ in each occurrence, independently is -H, -OH, a C1-C10 alkyl group or a tert-butyl group; A is -NHC(O)- or -C(O)O- and B is a bond or a C1-C24 alkylene, and i and j are 0, 1, 2, 3 or 4.

In other certain embodiments, the present invention is directed to macromolecular antioxidants represented by a structural formula selected from
20 Structural Formulas 1- 6, wherein R is:

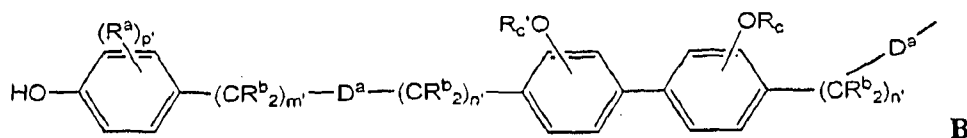

B

- 105 -

wherein:

D^a , for each occurrence, is independently $-C(O)NR_d-$, $-NR_dC(O)-$, $-NR_d-$, $-CR_d=N-$, $-C(O)-$, $-C(O)O-$, $-OC(O)-$, $-O-$, $-S-$, $-C(O)OC(O)-$ or a bond. In certain other embodiments D^a is $-C(O)O-$, $-OC(O)-$, $-C(O)NH-$, $-NHC(O)-$, $-NH-$, $-O-$ or $-C(O)-$. In certain other embodiments, D^a is $-NH-$, $-C(O)NH-$ or $-NHC(O)-$.
Optionally, D^a is not $-C(O)O-$, $-OC(O)-$, $-O-$ or $-NH-$. In various embodiments, the present invention relates to a compound of Structural Formula I and the attendant definitions, wherein D^a is $-OC(O)-$. In another embodiment, D^a is $-C(O)O-$. In another embodiment, D^a is $-C(O)NH-$. In another embodiment, D^a is $-NHC(O)-$. In another embodiment, D^a is $-NH-$. In another embodiment, D^a is $-CH=N-$. In another embodiment, D^a is $-C(O)-$. In another embodiment, D^a is $-O-$. In another embodiment, D^a is $-C(O)OC(O)-$. In another embodiment, D^a is a bond.

Each R_d is independently $-H$ or optionally substituted alkyl. In certain other embodiments R_d is $-H$ or an alkyl group. In certain other embodiments R_d is $-H$ or a C1-C10 alkyl group. In certain other embodiments R_d is $-H$.

R_c and R_c' are independently H or an optionally substituted alkyl. In one embodiment, R_c and R_c' are H . In another embodiment, one of R_c and R_c' is H and the other is an optionally substituted alkyl. More specifically, the alkyl is a C1-C10 alkyl. Even more specifically, the alkyl is a C10 alkyl.

R^a , for each occurrence, is independently an optionally substituted alkyl, optionally substituted aryl, optionally substituted alkoxy carbonyl, optionally substituted ester, $-OH$, $-NH_2$, or $-SH$. In certain other embodiments, each R^a is independently an optionally substituted alkyl or optionally substituted alkoxy carbonyl. In certain other embodiment each R^a is independently an alkyl or alkoxy carbonyl. In certain other embodiments each R^a is independently a C₁-C₆ alkyl or a C₁-C₆ alkoxy carbonyl. In certain other embodiments each R^a is independently *tert*-butyl or propoxy carbonyl. In certain other embodiments each R^a is independently an alkyl group. In certain embodiments each R^a is independently a bulky alkyl group. Suitable examples of bulky alkyl groups include butyl, *sec*-butyl, *tert*-butyl, 2-propyl, 1,1-dimethylhexyl, and the like. In certain embodiments each R^a is *tert*-butyl. In certain embodiments at least one R^a adjacent to the $-OH$ group is

- 106 -

a bulky alkyl group (e.g., butyl, *sec*-butyl, *tert*-butyl, 2-propyl, 1,1-dimethylhexyl, and the like). In certain other embodiments both R^a groups adjacent to -OH are bulky alkyl groups (e.g., butyl, *sec*-butyl, *tert*-butyl, 2-propyl, 1,1-dimethylhexyl, and the like). In another embodiment, both R^a groups are *tert*-butyl. In another
5 embodiment, both R^a groups are *tert*-butyl adjacent to the OH group.

R^b, for each occurrence, is independently H or optionally substituted alkyl. In certain embodiment, R^b is H.

Each n' and m' are independently integers from 0 to 18. In another embodiment, n' and m' in each occurrence, independently is 0 to 12. In yet another
10 embodiment, n' and m' in each occurrence, independently is 0 to 6.. In certain embodiments each n' and m' are independently integers from 0 to 2. In a specific embodiment, n' is 0. In another specific embodiment, m is an integer from 0 to 2. In another specific embodiment, n' is 0 and m' is 2.

Each p' is independently an integer from 0 to 4. In certain embodiments,
15 each p' is independently an integer from 0 to 2. In certain embodiments, p' is 2.

In one embodiment the first antioxidants which are suitable for use in the compositions and methods of the present invention are represented by:

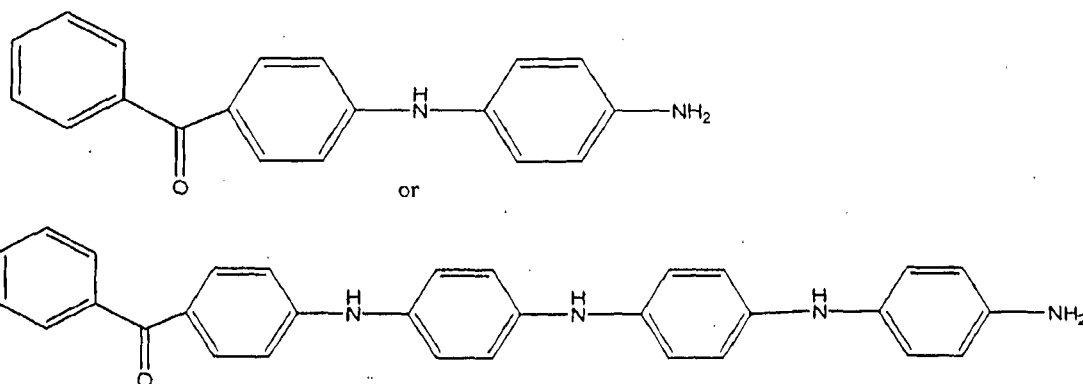

20

In an additional embodiment, for formulas 1-6 R is:

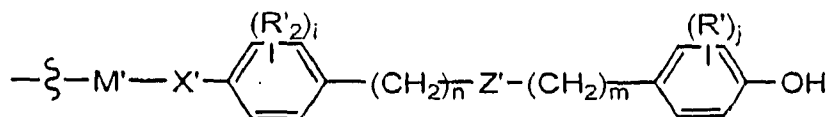

- 107 -

n and m in each occurrence, independently is 0 or a positive integer. In one embodiment, n and m in each occurrence, independently is 0 to 18. In another embodiment, n and m in each occurrence, independently is 0 to 12. In yet another embodiment, n and m in each occurrence, independently is 0 to 6.

5 i and j in each occurrence, independently is 0, 1, 2, 3 or 4. In one embodiment, i and j in each occurrence, independently is 0, 1 or 2. In a particular embodiment, i is 0. In another particular embodiment, j is 2.

Z' in each occurrence, independently is -C(O)O-, -OC(O)-, -C(O)NH-, -NHC(O)-, -NH-, -CH=N-, -C(O)-, -O-, -S-, -C(O)OC(O)- or a bond. In one
 10 embodiment, Z' is -C(O)O-. In another embodiment, Z' is -OC(O)-. In yet another embodiment, Z' is -C(O)NH-. In yet another embodiment, Z' is -NHC(O)-. In yet another embodiment, Z' is -NH-. In yet another embodiment, Z' is -CH=N-. In yet another embodiment, Z' is -C(O)-. In yet another embodiment, Z' is -O-. In yet another embodiment, Z' is -S-. In yet another embodiment, Z' is -C(O)OC(O)-. In
 15 yet another embodiment, Z' is a bond.

R' in each occurrence, independently is C1-C6 alkyl, -OH, -NH₂, -SH, an optionally substituted aryl, an ester or

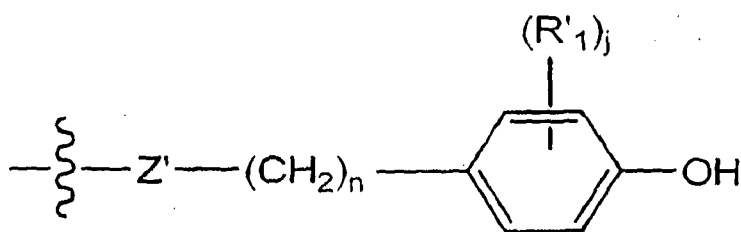

wherein at least one R' adjacent to the -OH group is an optionally substituted
 20 bulky alkyl group (e.g., butyl, *sec*-butyl, *tert*-butyl, 2-propyl, 1,1-dimethylhexyl, and the like).

R'₁ in each occurrence, independently is C1-C6 alkyl, an optionally substituted aryl, an optionally substituted aralkyl, -OH, -NH₂, -SH, or C1-C6 alkyl ester wherein at least one R₁ adjacent to the -OH group is a bulky alkyl group (e.g.,
 25 butyl, *sec*-butyl, *tert*-butyl, 2-propyl, 1,1-dimethylhexyl, and the like).

- 108 -

R'_2 in each occurrence, independently is C1-C6 alkyl, an optionally substituted aryl, an optionally substituted aralkyl, -OH, -NH₂, -SH, or ester.

X' in each occurrence, independently is -C(O)O-, -OC(O)-, -C(O)NH-, -NHC(O)-, -NH-, -CH=N-, -C(O)-, -O-, -S-, -C(O)OC(O)- or a bond. In one embodiment X' is -C(O)O-. In another embodiment X' is -OC(O)-. In yet another embodiment X' is -C(O)NH-. In yet another embodiment X' is -NHC(O)-. In yet another embodiment X' is -NH-. In yet another embodiment X' is -CH=N-. In yet another embodiment X' is -C(O)-. In yet another embodiment X' is -O-. In yet another embodiment X' is -S-. In yet another embodiment X' is -C(O)OC(O)-. In yet another embodiment X' is a bond.

M' is H, an optionally substituted aryl, C1-C20 linear or branched alkyl chain with or without any functional group anywhere in the chain, or

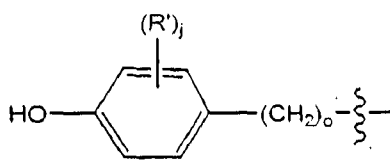

o is 0 or a positive integer. Preferably o is 0 to 18. More preferably o is 0 to 6.

In yet another embodiment, for formulas 1-6 R is:

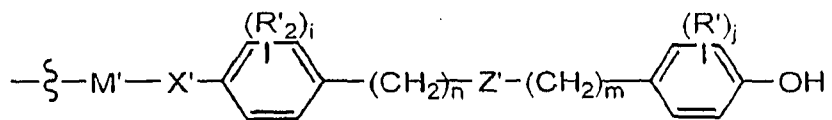

R'_2 is C1-C6 alkyl, -OH, -NH₂, -SH, aryl, aralkyl, ester, or

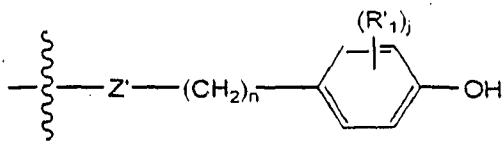

wherein at least one R'_2 is -OH, and the values and preferred values for the remainder of the variables for R are as described immediately above.

In yet another embodiment, the present invention relates to a compound of formula 1-6, wherein M is

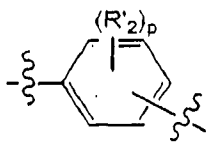

Wherein p is 0, 1, 2, 3 or 4; and the values and preferred values for the remainder of the variables are as described above for formulas 1-6.

Specific examples of first macromolecular antioxidants which are suitable for use in the compositions and methods of the present invention, for example, high molecular weight dimers, and tetramers etc., are shown below.

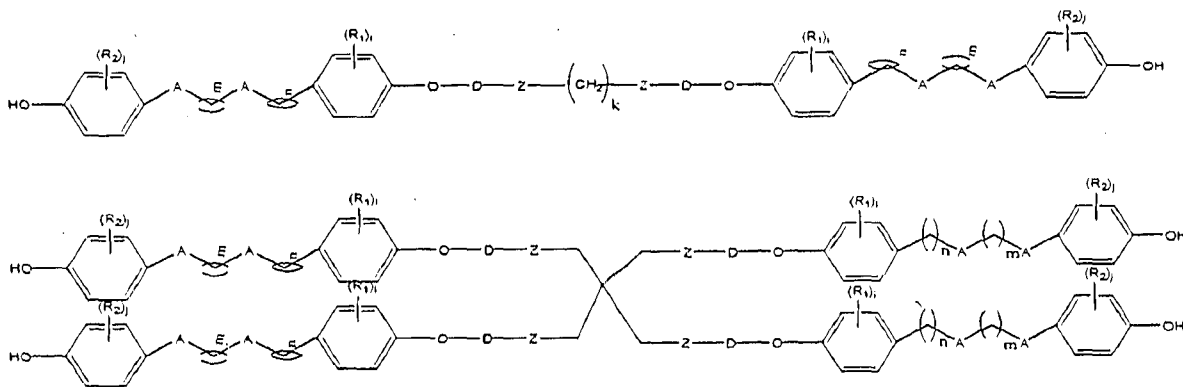

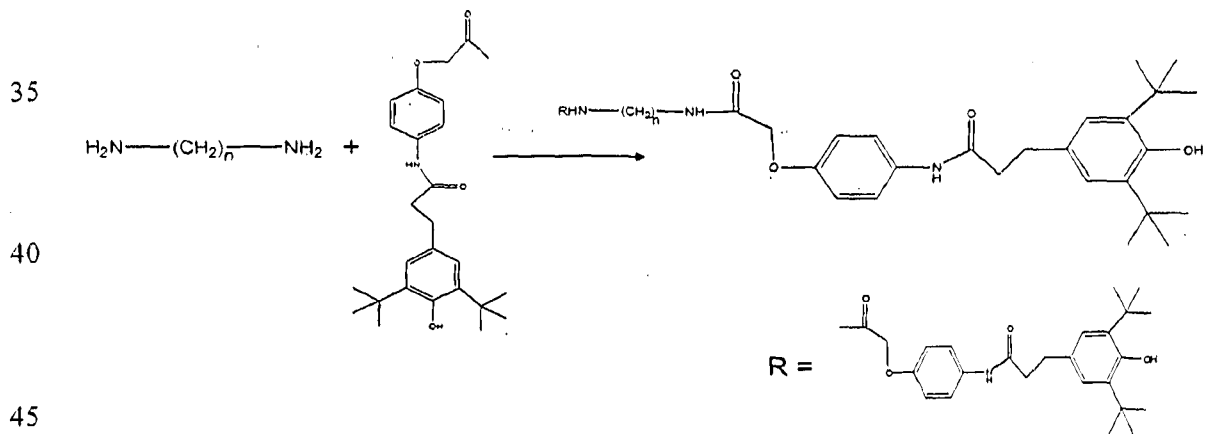
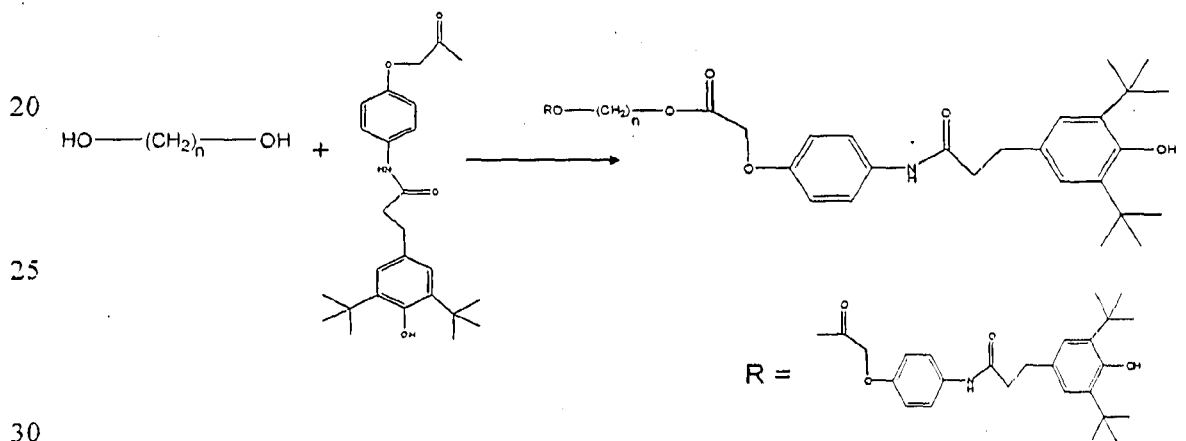
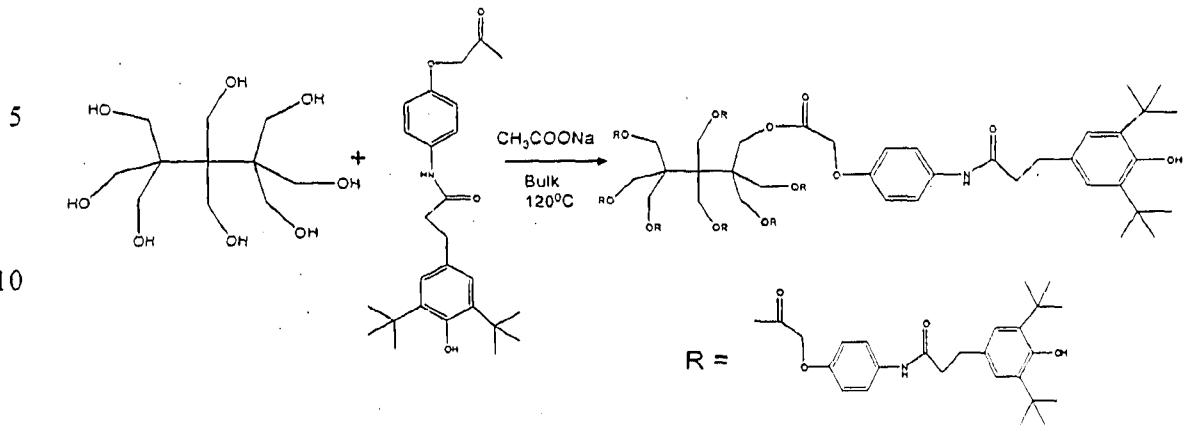

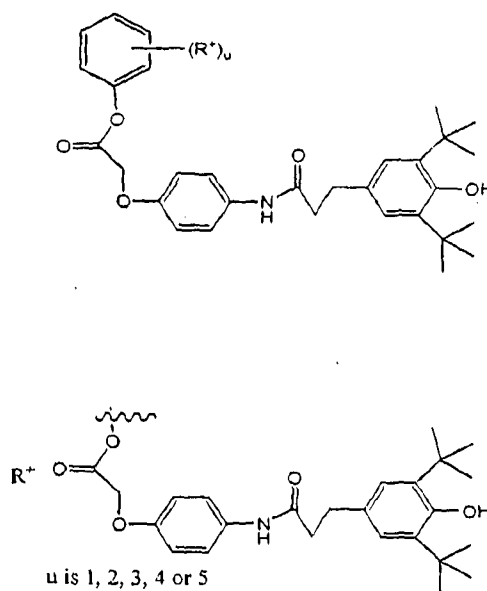
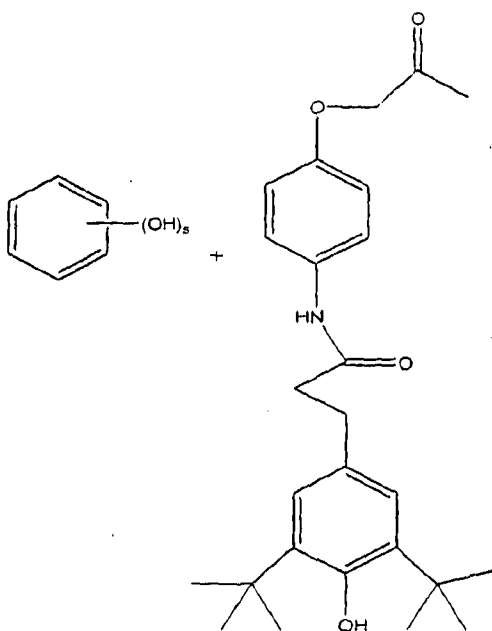
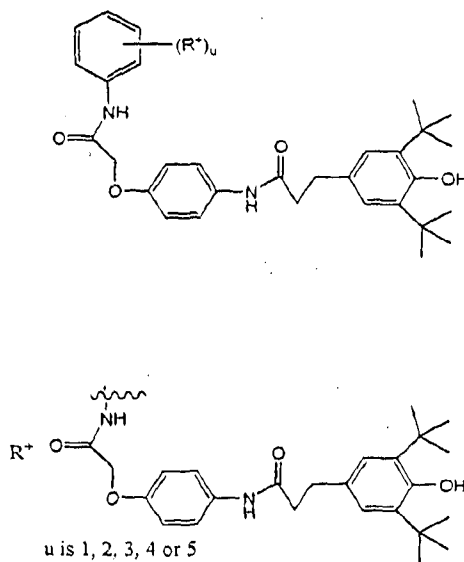
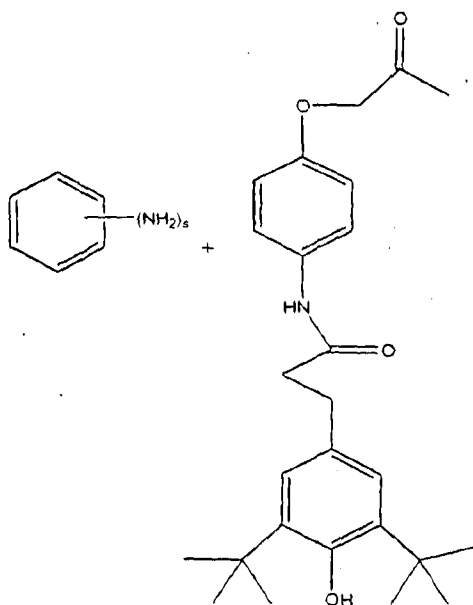

5

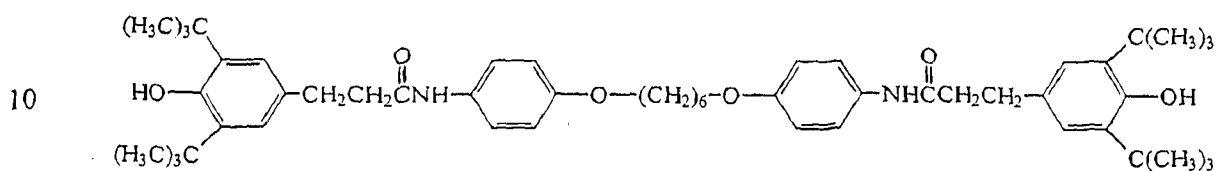

5 The values and preferred values for the variables are as described above.

In another embodiment, the first antioxidants which are suitable for use in the compositions and methods of the present invention are represented by a structural formula selected from 7a, 7b, 8a and 8b:

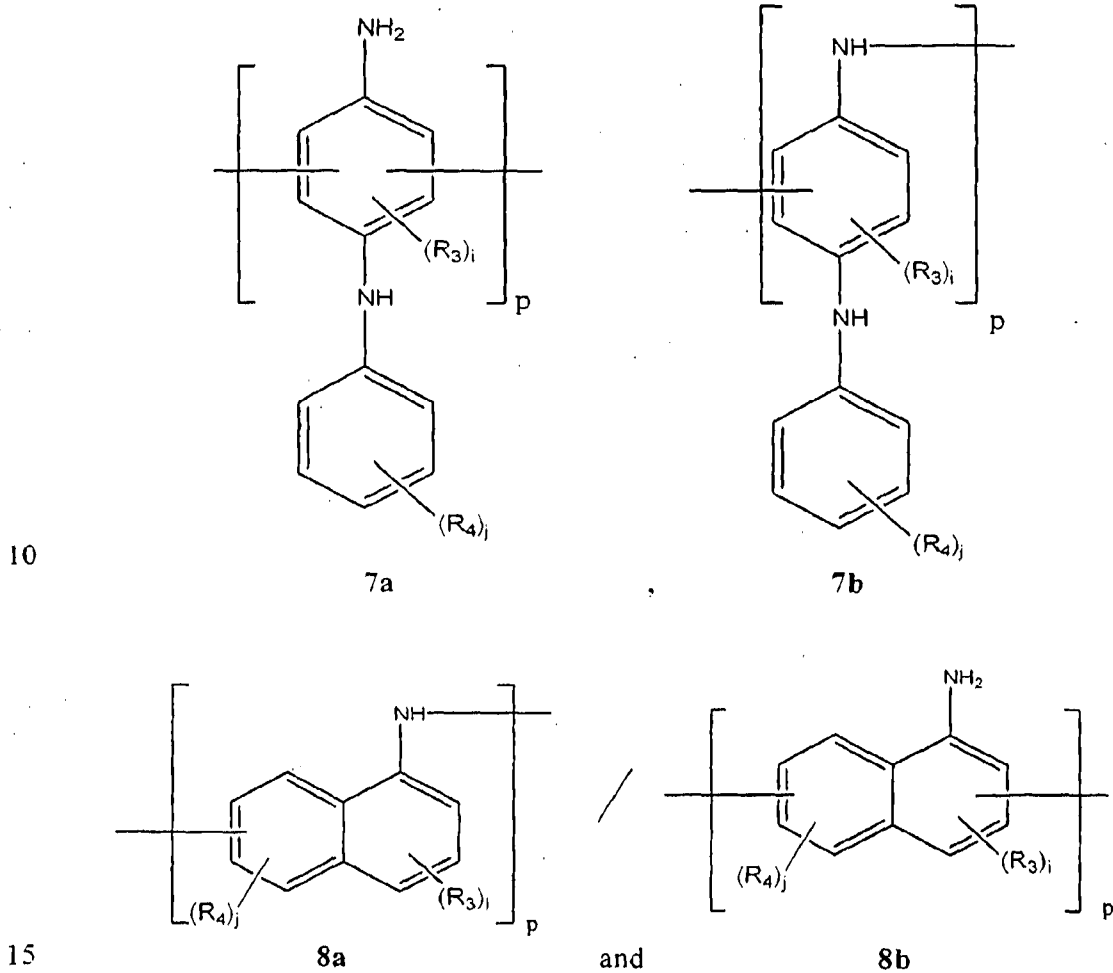

R₃ and R₄ in each occurrence, independently is C1-C16 alkyl, -O-(C1-C16 alkyl), -NH(aryl), -NH₂, -OH, or -SH.

p in each occurrence, independently is an integer equal to or greater than 2.

Specific examples of polymers which are useful in the compositions methods of the present invention include:

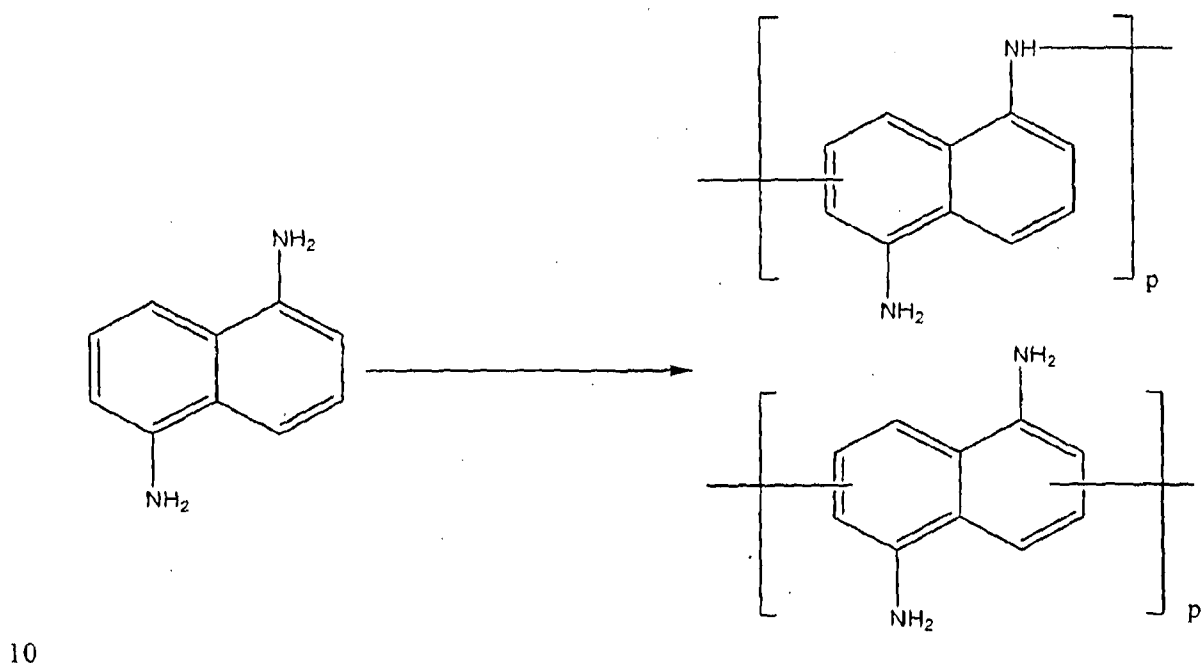
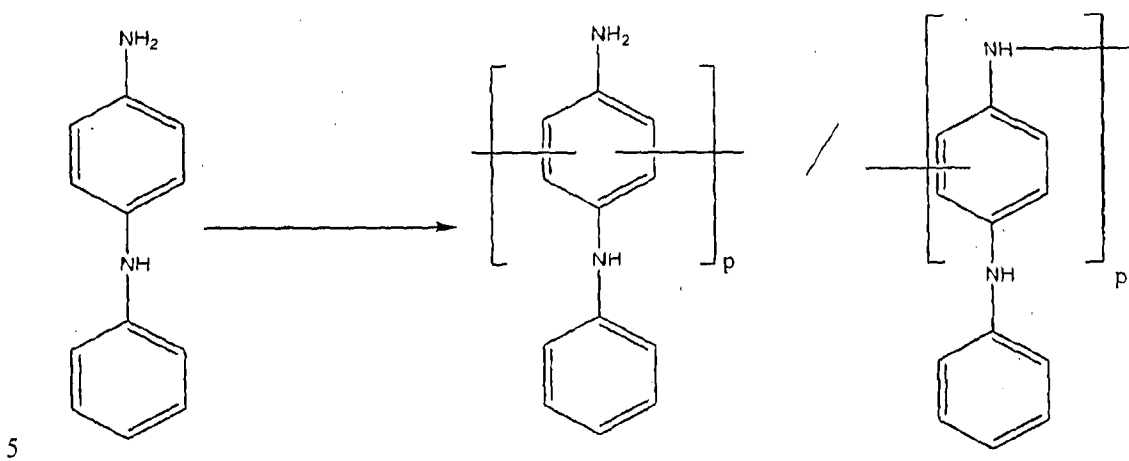

In one embodiment antioxidants suitable for use in the methods and compositions of the present invention include compounds represented by Structural Formula I:

- 114 -

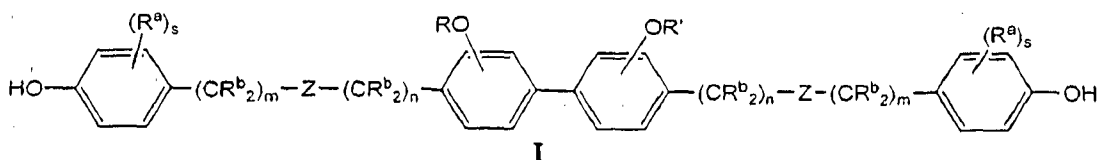

wherein:

R and R' are independently H or optionally substituted alkyl and at least one
5 of R and R' is H;

Z is $-\text{C}(\text{O})\text{NR}^c-$, $-\text{NR}^c\text{C}(\text{O})-$, $-\text{NR}^c-$, $-\text{CR}^c=\text{N}-$, $-\text{C}(\text{O})-$, $-\text{C}(\text{O})\text{O}-$,
 $-\text{OC}(\text{O})-$, $-\text{O}-$, $-\text{S}-$, $-\text{C}(\text{O})\text{OC}(\text{O})-$ or a bond;

R^c is independently H or optionally substituted alkyl;

R^a, for each occurrence, is independently an optionally substituted alkyl,
10 optionally substituted aryl, optionally substituted alkoxy carbonyl, optionally
substituted ester, $-\text{OH}$, $-\text{NH}_2$, $-\text{SH}$;

R^b, for each occurrence, is independently H or optionally substituted alkyl;

s, for each occurrence, is independently an integer from 0 to 4; and

m and n, for each occurrence, are independently integers from 0 to 6.

15 In one embodiment antioxidants suitable for use in the methods and
compositions of the present invention include compounds represented by Structural
Formula II:

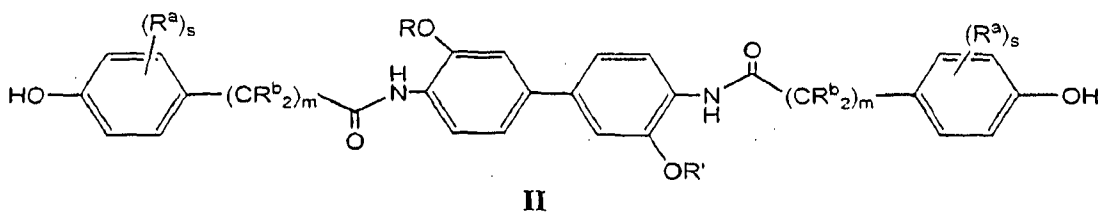

20 wherein:

R and R' are independently H or optionally substituted alkyl and at least one
of R and R' is H;

- 115 -

R^a , for each occurrence, is independently an optionally substituted alkyl, optionally substituted aryl, optionally substituted alkoxy carbonyl, optionally substituted ester, -OH, -NH₂, or -SH;

R^b , for each occurrence, is independently H or optionally substituted alkyl.

5 s , for each occurrence, is independently an integer from 0 to 4; and

m , for each occurrence, is independently an integer from 0 to 6.

In one embodiment antioxidants suitable for use in the methods and compositions of the present invention include compounds represented by Structural Formula III:

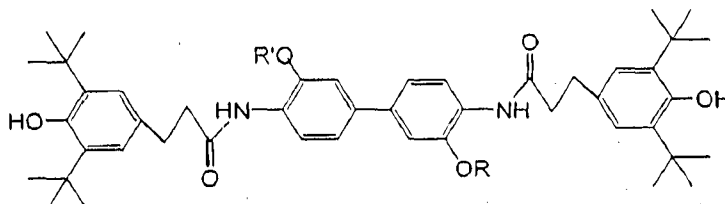

10

III

wherein R and R' are independently H or optionally substituted alkyl and at least one of R and R' is H.

In one embodiment antioxidants suitable for use in the methods and compositions of the present invention include a compound A represented by the following structural formula:

15

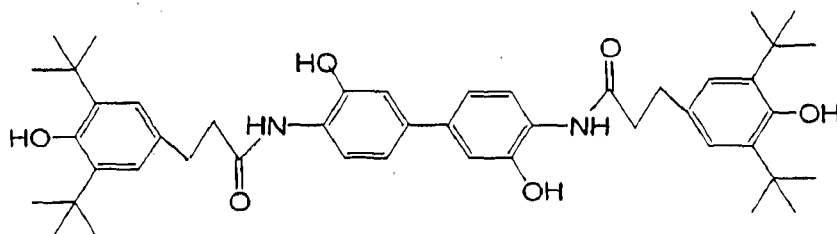

(A)

In one embodiment antioxidants suitable for use in the methods and compositions of the present invention include a compound B represented by the following structural formula:

20

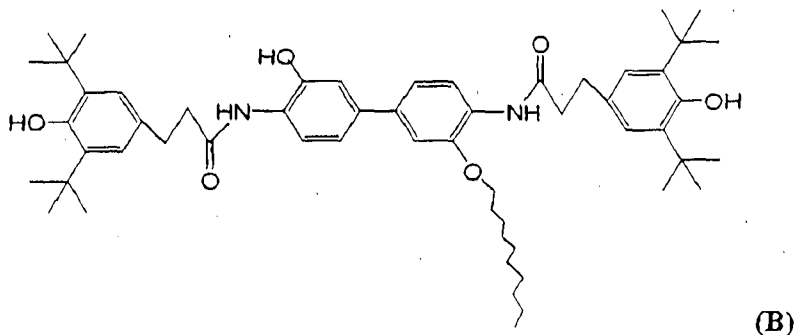

In one embodiment, the first antioxidants which are suitable for use in the compositions and methods of the present invention include antioxidant polymers which comprises at least one repeat unit selected from:

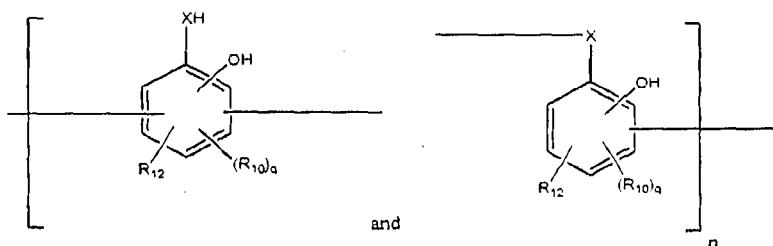

X is -O-, -NH- or -S-. Each R₁₀ is independently an optionally substituted C1-C10 alkyl group, an optionally substituted aryl group, and optionally substituted alkoxy group, an optionally substituted carbonyl group, an optionally substituted alkoxy carbonyl group, an optionally substituted aryloxy carbonyl group, -OH, -SH or -NH₂ or two R₁₀ groups on adjacent carbon atoms join together to form an optionally substituted aromatic ring or an optionally substituted carbocyclic or heterocyclic non- aromatic ring. q is an integer from 0 to 2. R₁₂ is a bulky alkyl group substituent bonded to a ring carbon atom adjacent (*ortho*) to a ring carbon atom substituted with an -OH, -SH or -NH₂ group. In certain embodiments, R₁₂ is a bulky alkyl group substituent bonded to a ring carbon atom *meta* or *para* to a ring carbon atom substituted with an -OH, -SH or -NH₂ group.

In certain embodiments, the first antioxidants which are suitable for use in the compositions and methods of the present invention include antioxidant polymers which comprises at least one repeat unit selected from:

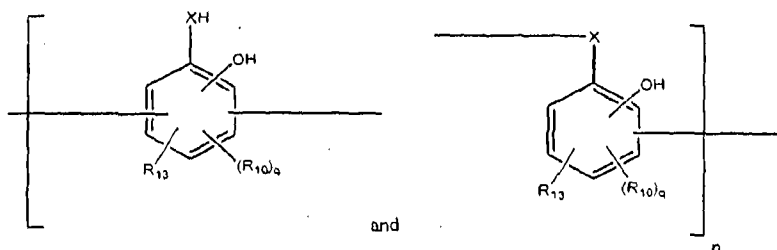

R_{13} is an aryl group. In certain embodiments, the aryl group is adjacent (or *ortho*) to an -OH, -SH or -NH₂ group. In certain embodiments, the aryl group is adjacent (or *ortho*) to an -OH group. In certain embodiments, the aryl group is *meta* or *para* to an -OH, -SH or -NH₂ group. Each R_{10} is independently an optionally substituted C1-C10 alkyl group, an optionally substituted aryl group, and optionally substituted alkoxy group, an optionally substituted carbonyl group, an optionally substituted alkoxy carbonyl group, an optionally substituted aryloxy carbonyl group, -OH, -SH or -NH₂ or two R_{10} groups on adjacent carbon atoms join together to form an optionally substituted aromatic ring or an optionally substituted carbocyclic or heterocyclic non- aromatic ring. q is an integer from 0 to 2. R_{12} is a bulky alkyl group substituent bonded to a ring carbon atom adjacent (*ortho*) to a ring carbon atom substituted with an -OH group.

In certain embodiments, the -OH groups in the structures in the two immediately preceding paragraphs may be replaced with -SH or -NH₂.

In one embodiment, the first antioxidants which are suitable for use in the compositions and methods of the present invention include a macromonomer represented by the following structural formula:

- 118 -

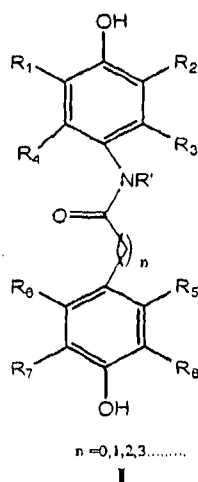

Each of R and R₁-R₈ are independently -H, -OH, or a C1-C10 alkyl group. n is an integer from 0 to 24. R' is -H, optionally substituted C1-C20 alkyl or optionally substituted aryl group.

5

STABILIZED LUBRICANT OIL COMPOSITIONS

Lubricants, lubricant oils, mixtures thereof and compositions comprising lubricants and lubricant oils can be improved by the methods of the present invention, by contacting the lubricant, lubricant oil, mixtures thereof or composition
10 comprising the lubricant or lubricant oil or mixtures thereof with antioxidants, additives and mixtures thereof as described herein.

As used here, the terms "lubricants" and "lubricant oils" can be used interchangeably. Examples of lubricants suitable for use in the compositions and methods of the present invention include, but are not limited to: i) petroleum based
15 oils (Group I, II and III), ii) synthetic oils (Group IV) and iii) biolubricant oils (vegetable oils such as canola, soybean, corn oil etc.,). Group I oils, as defined herein are solvent refined base oils. Group II oils, as defined herein are modern conventional base oils made by hydrocracking and early wax isomerization, or hydroisomerization technologies and have significantly lower levels of impurities
20 than Group I oils. Group III oils, as defined herein are unconventional base oils. Groups I-III differ in impurities, and viscosity index as is shown in Kramer *et al.* "The Evolution of Base Oil Technology" *Turbine Lubrication in the 21st Century* ASTM STP #1407 W.R. Herguth and T.M. Wayne, Eds., American Society for

- 119 -

Testing and Materials, West Conshohocken, PA, 2001 the entire contents of which are incorporated herein by reference. Group IV oils as defined herein are “synthetic” lubricant oils, including for example, poly-alpha olefins (PAOs). Biolubricants as defined herein are lubricants which contain at least 51% biomaterial (see Scott Fields, Environmental Health Perspectives, volume 111, number 12, 5 September 2003, the entire contents of which are incorporated herein by reference). Other examples of lubricant oils can be found in Melvyn F. Askew “Biolubricants-Market Data Sheet” IENICA, August 2004 (as part of the IENICA workstream of the IENICA-INFORRM project); Taylor *et al.* “Engine lubricant Trends Since 10 1990” paper accepted for publication in the Proceedings I. Mech. E. Part J, Journal of Engineering Tribology, 2005 (Vol. 219 p 1-16); and Desplanches *et al.* “Formulating Tomorrow’s Lubricants” page 49-52 of The Paths to Sustainable Development, part of special report published in October 2003 by Total; the entire contents of each of which are incorporated herein by reference. Biolubricants are 15 often but not necessarily, based on vegetable oils. Vegetable derived, for example, from rapeseed, sunflower, palm and coconut can be used as biolubricants. They can also be synthetic esters which may be partly derived from renewable resources. They can be made from a wider variety of natural sources including solid fats and low grade or waste materials such as tallows. Biolubricants in general offer rapid 20 biodegradability and low environmental toxicity.

ADDITIVES

Examples of first additives suitable for use in the compositions and methods of the present invention, include but are not limited to, surface additives, 25 performance enhancing additives and lubricant protective additives.

Surface additives: In certain embodiments of the present invention, surface additives can protect the surfaces that are lubricated from wear, corrosion, rust, and frictions. Examples of these surface additives suitable for use in the compositions and methods of the present invention include, but are not limited to: (a) rust 30 inhibitors, (b) corrosion inhibitors, (c) extreme pressure agents, (d) tackiness agents, (e) antiwear agents, (f) detergents and dispersants, (g) compounded oil (like fat or

- 120 -

vegetable oil to reduce the coefficient of friction without affecting the viscosity), (h) antimisting, (i) seal swelling agents and (j) biocides.

Performance Enhancing Additives: In certain embodiments of the present invention, performance enhancing additives improve the performance of lubricants.

5 Examples of these performance enhancing additives suitable for use in the Compositions and methods of the present invention include, but are not limited to: (a) pour-point depressants, (b) viscosity index modifiers (c) emulsifiers, and (d) demulsifiers.

10 Lubricant Protective Additives: In certain embodiments of the present invention, lubricant protective additives maintain the quality of oil from oxidation and other thermal degradation processes. Examples of these lubricant protective additives suitable for use in the compositions and methods of the present invention include, but are not limited to: (a) oxidation inhibitors and (b) foam inhibitors.

15 OTHER LUBRICANT ADDITIVES

In certain embodiments, a second additive can be used in the compositions and methods of the present invention in combination with the first antioxidant and the first additive as described above. Examples of second additives suitable for use in the compositions and methods of the present invention include, include but are not limited to, for example, dispersants, detergents, corrosion inhibitors, rust inhibitors, metal deactivators, antiwear and extreme pressure agents, antifoam agents, friction modifiers, seal swell agents, demulsifiers, viscosity index improvers, pour point depressants, and the like. See, for example, U.S. Patent No. 5,498,809 for a description of useful lubricating oil composition additives, the disclosure of which is incorporated herein by reference in its entirety.

20 Dispersants: Examples of dispersants suitable for use in the compositions and methods of the present invention include, but are not limited to: polybutenylsuccinic acid-amides, -imides, or -esters, polybutenylphosphonic acid derivatives, Mannich Base ashless dispersants, and the like.

30 Detergents: Examples of detergents suitable for use in the compositions and methods of the present invention include, but are not limited to: metallic phenolates,

- 121 -

metallic sulfonates, metallic salicylates, metallic phosphonates, metallic thiophosphonates, metallic thiopyrophosphonates, and the like.

Corrosion Inhibitors: Examples of corrosion inhibitors suitable for use in the compositions and methods of the present invention include, but are not limited to:
5 phosphosulfurized hydrocarbons and their reaction products with an alkaline earth metal oxide or hydroxide, hydrocarbyl-thio-substituted derivatives of 1,3,4-thiadiazole, thiadiazole polysulphides and their derivatives and polymers thereof, thio and polythio sulphenamides of thiadiazoles such as those described in U.K. Patent Specification 1,560,830, and the like.

10 Rust Inhibitors: Examples of rust inhibitors suitable for use in the compositions and methods of the present invention include, but are not limited to: nonionic surfactants such as polyoxyalkylene polyols and esters thereof, anionic surfactants such as salts of alkyl sulfonic acids, and other compounds such as alkoxyated fatty amines, amides, alcohols and the like, including alkoxyated fatty
15 acid derivatives treated with C9 to C16 alkyl-substituted phenols (such as the mono- and di-heptyl, octyl, nonyl, decyl, undecyl, dodecyl and tridecyl phenols).

Metal Deactivators: Metal deactivators as used herein, are the additives which form an inactive film on metal surfaces by complexing with metallic ions and reducing, for example, the catalytic effect on metal gum formation and other
20 oxidation. Examples of metal deactivators suitable for use in the compositions and methods of the present invention include, but are not limited to: N,N-disubstituted aminomethyl-1,2,4-triazoles, N,N-disubstituted aminomethyl-benzotriazoles, mixtures thereof, and the like.

Antiwear and Extreme Pressure Additives: Antiwear and extreme pressure
25 additives, as used herein, react with metal surfaces to form a layer with lower shear strength than metal, thereby preventing metal to metal contact and reducing friction and wear. Examples of antiwear additives suitable for use in the compositions and methods of the present invention include, but are not limited to: sulfurized olefins, sulfurized esters, sulfurized animal and vegetable oils, phosphate esters,
30 organophosphites, dialkyl alkylphosphonates, acid phosphates, zinc dialkyldithiophosphates, zinc diaryldithiophosphates, organic dithiophosphates, organic phosphorothiolates, organic thiophosphates, organic dithiocarbamates,

- 122 -

dimercaptothiadiazole derivatives, mercaptobenzothiazole derivatives, amine phosphates, amine thiophosphates, amine dithiophosphates, organic borates, chlorinated paraffins, and the like.

5 Antifoam Agents: Examples of antifoam agents suitable for use in the compositions and methods of the present invention include, but are not limited to: polysiloxanes and the like.

10 Friction Modifiers: Examples of friction modifiers suitable for use in the compositions and methods of the present invention include, but are not limited to: fatty acid esters and amides, organic molybdenum compounds, molybdenum dialkylthiocarbamates, molybdenum dialkyl dithiophosphates, molybdenum dithiolates, copper oleate, copper salicylate, copper dialkyldithiophosphates, molybdenum disulfide, graphite, polytetrafluoroethylene, and the like.

15 Seal Swell Agents: Seal swell agents, as used herein, react chemically with elastomers to cause slight swell thus improving low temperature performance especially in, for example, aircraft hydraulic oil. Examples of seal swell agents suitable for use in the compositions and methods of the present invention include, but are not limited to: dioctyl sebacate, dioctyl adipate, dialkyl phthalates, and the like.

20 Demulsifiers: Demulsifiers, as used herein promote separation of oil and water in lubricants exposed to water. Examples of demulsifiers suitable for use in the compositions and methods of the present invention include, but are not limited to: the esters described in U.S. Patent Nos. 3,098,827 and 2,674,619 incorporated herein by reference.

25 Viscosity Index Improvers: Examples of viscosity index improvers suitable for use in the compositions and methods of the present invention include, but are not limited to: olefin copolymers, dispersant olefin copolymers, polymethacrylates, vinylpyrrolidone/methacrylate-copolymers, polyvinylpyrrolidones, polybutanes, styrene/-acrylate-copolymers, polyethers, and the like.

30 Pour Point Depressants: Pour point depressants as used herein reduce the size and cohesiveness of crystal structure resulting in low pour point and increased flow at low-temperatures. Examples of pour point depressants suitable for use in the

compositions and methods of the present invention include, but are not limited to: polymethacrylates, alkylated naphthalene derivatives, and the like.

OTHER ANTIOXIDANTS AND STABILIZERS

5 In certain embodiments, a second antioxidant or a stabilizer can be used in the compositions and methods of the present invention in combination with the first antioxidant and the first additive and optionally the second additive as described above. Examples of second antioxidants suitable for use in the compositions and methods of the present invention include, include but are not limited to:

- 10 1. Amine Antioxidants
 - 1.1. Alkylated Diphenylamines, for example octylated diphenylamine; styrenated diphenylamine; mixtures of mono- and dialkylated tert-butyl-tert-octyldiphenylamines; and 4,4'-dicumyldiphenylamine.
 - 1.2. Phenyl Naphthylamines, for example N-phenyl-1-naphthylamine; N-phenyl-15 2-naphthylamine; tert-octylated N-phenyl-1-naphthylamine.
 - 1.3. Derivatives of para-Phenylenediamine, for example N,N'-diisopropyl-p-phenylenediamine; N,N'-di-sec-butyl-p-phenylenediamine; N,N'-bis(1,4-dimethylpentyl)-p-phenylenediamine; N,N'-bis(1-ethyl-3-methylpentyl)-p-phenylenediamine; N,N'-bis(1-methylheptyl)-p-phenylenediamine; N,N'-20 diphenyl-p-phenylenediamine; N,N'-di-(naphthyl-2)-p-phenylenediamine; N-isopropyl-N'-phenyl-p-phenylenediamine; N-(1,3-dimethylbutyl)-N'-phenyl-p-phenylenediamine; N-(1-methylheptyl)-N'-phenyl-p-phenylenediamine; N-cyclohexyl-N'-phenyl-p-phenylenediamine; N,N'-dimethyl-N,N'-di-sec-butyl-p-phenylenediamine.
 - 25 1.4. Phenothiazines, for example phenothiazine; 2-methylphenothiazine; 3-octylphenothiazine; 2,8-dimethylphenothiazine; 3,7-dimethylphenothiazine; 3,7-diethylphenothiazine; 3,7-dibutylphenothiazine; 3,7-dioctylphenothiazine; 2,8-dioctylphenothiazine.
 - 1.5. Dihydroquinolines, for example 2,2,4-trimethyl-1,2-dihydroquinoline or a 30 polymer thereof.
2. Phenolic Antioxidants

- 2.1. Alkylated monophenols, for example 2,6-di-tert-butyl-4-methylphenol; 2,6-di-tert-butylphenol; 2-tert-butyl-4,6-dimethylphenol; 2,6-di-tert-butyl-4-ethylphenol; 2,6-di-tert-butyl-4-n-butylphenol; 2,6-di-tert-butyl-4-isobutylphenol; 2,6-di-tert-butyl-4-sec-butylphenol; 2,6-di-tert-butyl-4-octadecylphenol; 2,6-di-tert-butyl-4-nonylphenol; 2,6-dicyclopentyl-4-methylphenol; 2-(α -methylcyclohexyl)-4,6-dimethylphenol; 2,6-dioctadecyl-4-methylphenol; 2,4,6-tricyclohexylphenol; 2,6-di-tert-butyl-4-methoxymethylphenol; 2,6-di-tert-butyl-4-dimethylaminomethylphenol; o-tert-butylphenol.
- 10 2.2. Alkylated hydroquinones, for example 2,6-di-tert-butyl-4-methoxyphenol; 2,5-di-tert-butylhydroquinone; 2,5-di-tert-amylhydroquinone; 2,6-di-phenyl-4-octadecyloxyphenol.
- 2.3. Hydroxylated thiodiphenyl ethers, for example 2,2'-thiobis(6-tert-butyl-4-methylphenol); 2,2'-thiobis(4-octylphenol); 4,4'-thiobis(6-tert-butyl-3-methylphenol); 4,4'-thiobis(6-tert-butyl-2-methylphenol).
- 15 2.4. Alkylidenebisphenols, for example 2,2'-methylenebis(6-tert-butyl-4-methylphenol); 2,2'-methylenebis(6-tert-butyl-4-ethylphenol); 2,2'-methylenebis(4-methyl-6-(α -methylcyclohexyl)phenol); 2,2'-methylenebis(4-methyl-6-cyclohexylphenol); 2,2'-methylenebis(6-nonyl-4-methylphenol); 2,2'-methylenebis(4,6-di-tert-butylphenol); 2,2'-ethylidenebis(6-tert-butyl-4-isobutylphenol); 2,2'-methylenebis[6- α -methylbenzyl)-4-nonylphenol]; 2,2'-methylenebis[6-(α,α -dimethylbenzyl)-4-nonylphenol]; 4,4'-methylenebis(2,6-di-tert-butylphenol); 4,4'-methylenebis(6-tert-butyl-2-methylphenol); 1,1-bis(5-tert-butyl-4-hydroxy-2-methylphenyl)butane; 2,6-di(3-tert-butyl-5-methyl-2-hydroxybenzyl)-4-methylphenol; 1,1,3-tris(5-tert-butyl-4-hydroxy-2-methylphenyl)-3-n-dodecylmercaptobutane; ethylene glycol bis[3,3-bis(3'-tert-butyl-4'-hydroxyphenyl)butyrate]; di(3-tert-butyl-4-hydroxy-5-methylphenyl)dicyclopentadiene; di[2-(3'-tert-butyl-2'-hydroxy-5'-methylbenzyl)-6-tert-butyl-4-methylphenyl]terephthalate.
- 20 25 30 2.5. Benzyl compounds, for example 1,3,5-tris(3,5-di-tert-butyl-4-hydroxybenzyl)-2,4,6-trimethylbenzene; di(3,5-di-tert-butyl-4-

- hydroxybenzyl)sulfide; 3,5-di-tert-butyl-4-hydroxybenzylmercaptoacetic acid isooctyl ester; bis(4-tert-butyl-3-hydroxy-2,6-dimethylbenzyl)dithioterephthalate; 1,3,5-tris(3,5-di-tert-butyl-4-hydroxybenzyl)isocyanurate; 1,3,5-tris(4-tert-butyl-3-hydroxy-2,6-dimethylbenzyl)isocyanurate; 3,5-di-tert-butyl-4-hydroxybenzylphosphonic acid dioctadecyl ester; 3,5-di-tert-butyl-4-hydroxybenzylphosphonic acid mono-ethyl ester calcium salt.
- 5
- 2.6. Acylaminophenols, for example 4-hydroxylauric acid anilide; 4-hydroxystearic acid anilide; 2,4-bis-octylmercapto-6-(3,5-di-tert-butyl-4-hydroxyaniline)-s-triazine; N-(3,5-di-tert-butyl-4-hydroxyphenyl)carbamic acid octyl ester.
- 10
- 2.7. Esters of β -(3,5-di-tert-butyl-4-hydroxyphenyl)propionic acid with mono- or polyhydric alcohols, e.g. with methanol; octadecanol; 1,6-hexanediol; neopentyl glycol; thiodiethylene glycol; diethylene glycol; triethylene glycol; pentaerythritol; tris(hydroxyethyl)isocyanurate; and di(hydroxyethyl)oxalic acid diamide.
- 15
- 2.8. Esters of β -(5-tert-butyl-4-hydroxy-3-methylphenyl)propionic acid with mono- or polyhydric alcohols, e.g. with methanol; octadecanol; 1,6-hexanediol; neopentyl glycol; thiodiethylene glycol; diethylene glycol; triethylene glycol; pentaerythritol; tris(hydroxyethyl)isocyanurate; and di(hydroxyethyl)oxalic acid diamide.
- 20
- 2.9. Amides of β -(3,5-di-tert-butyl-4-hydroxyphenyl)propionic acid, e.g., N,N'-di(3,5-di-tert-butyl-4-hydroxyphenyl-propionyl)hexamethylenediamine ; N,N'-di(3,5-di-tert-butyl-4-hydroxyphenylpropionyl)trimethylenediamine; N,N'-di-(3,5-di-tert-butyl-4-hydroxyphenylpropionyl)hydrazine.
- 25
3. Sulfurized organic compounds, for example aromatic, alkyl, or alkenyl sulfides and polysulfines; sulfurized olefins; sulfurized fatty acid esters; sulfurized ester olefins; sulfurized oils; esters of β -thiodipropionic acid; sulfurized Diels-Alder adducts; sulfurized terpene compounds; and mixtures thereof.
- 30
4. Organo-borate compounds, for example alkyl- and aryl- (and mixed alkyl, aryl) substituted borates.

- 126 -

5. Phosphite and phosphate antioxidants, for example alkyl- and aryl- (and mixed alkyl, aryl) substituted phosphites, and alkyl- and aryl- (and mixed alkyl, aryl) substituted dithiophosphates such as O,O,S-trialkyl dithiophosphates, O,O,S-triaryldithiophosphates and dithiophosphates having mixed substitution by alkyl and aryl groups, phosphorothionyl sulfide, phosphorus-containing silane, polyphenylene sulfide, amine salts of phosphinic acid and quinone phosphates.
 6. Copper compounds, for example copper dihydrocarbyl thio- or dithiophosphates, copper salts of synthetic or natural carboxylic acids, copper salts of alkenyl carboxylic acids or anhydrides such as succinic acids or anhydrides, copper dithiocarbamates, copper sulphonates, phenates, and acetylacetonates. The copper may be in cuprous (Cu^{I}) or cupric (Cu^{II}) form.
 7. Zinc dithiodiphosphates, for example zinc dialkyldithiophosphates, diphenyldialkyldithiophosphates, and di(alkylphenyl)dithiophosphates.
- 15 In one embodiment, the compositions for use in the methods of the present invention, include but are not limited to:
- a. a first antioxidant (in the concentration range, from about 0.0001% to about 50%, from about 0.0005% to about 20%, from about 0.005% to about 10%, from about 0.05% to about 5% or from about 0.01% to about 1%) with a first additive selected from the group comprising a surface additive, a performance enhancing additive and a lubricant performance additive, for example, in amounts of from about 0.0005% to about 50%, from about 0.0001% to about 20%, from about 0.005% to about 10%, from about 0.05% to about 5% or from about 0.01% to about 1% by weight, based on the weight of lubricant to be stabilized.
 - 25 b. the first antioxidant and the first additive as described in a. and a second additive, for example, in concentrations of from about 0.0001% to about 50% by weight, about 0.0005% to about 20% by weight, about 0.001% to about 10% by weight, from about 0.01% to about 5% by weight, from about 0.05% to about 1% by weight from about 0.1% to about 1% by weight based on the overall weight of the lubricant to be stabilized.
 - 30 c. the first antioxidant and the first additive as described in a. and optionally the second additive as described in b. and a second antioxidant, for example,

- 127 -

Irganox[®] 1010, Irganox[®] 1330, Irganox[®] 1076, Irganox[®] 5057 and Irganox[®] 1135 in the concentration range, from about 0.0001% to about 50%, from about 0.0005% to about 20%, from about 0.005% to about 10%, from about 0.05% to about 5% or from about 0.01% to about 1%) by weight, based on the weight of lubricant to be
5 stabilized.

The term "alkyl" as used herein means a saturated straight-chain, branched or cyclic hydrocarbon. When straight-chained or branched, an alkyl group is typically C1-C8, more typically C1-C6; when cyclic, an alkyl group is typically C3-C12, more typically C3-C7 alkyl ester. Examples of alkyl groups include methyl,
10 ethyl, *n*-propyl, *iso*-propyl, *n*-butyl, *sec*-butyl and *tert*-butyl and 1,1-dimethylhexyl.

The term "alkoxy" as used herein is represented by -OR**, wherein R** is an alkyl group as defined above.

The term "carbonyl" as used herein is represented by -C(=O)R**, wherein R** is an alkyl group as defined above.

15 The term "alkoxycarbonyl" as used herein is represented by -C(=O)OR**, wherein R** is an alkyl group as defined above.

The term "aromatic group" includes carbocyclic aromatic rings and heteroaryl rings. The term "aromatic group" may be used interchangeably with the terms "aryl", "aryl ring", "aromatic ring", "aryl group" and "aromatic group".

20 Carbocyclic aromatic ring groups have only carbon ring atoms (typically six to fourteen) and include monocyclic aromatic rings such as phenyl and fused polycyclic aromatic ring systems in which a carbocyclic aromatic ring is fused to one or more aromatic rings (carbocyclic aromatic or heteroaromatic)r. Examples include 1-naphthyl, 2-naphthyl, 1-anthracyl and 2-anthracyl. Also included within the scope of
25 the term "carbocyclic aromatic ring", as it is used herein, is a group in which an aromatic ring is fused to one or more non-aromatic rings (carbocyclic or heterocyclic), such as in an indanyl, phthalimidyl, naphthimidyl, phenanthridinyl, or tetrahydronaphthyl, where the radical or point of attachment is on the aromatic ring.

The term "heteroaryl", "heteroaromatic", "heteroaryl ring", "heteroaryl
30 group" and "heteroaromatic group", used alone or as part of a larger moiety as in "heteroaralkyl" refers to heteroaromatic ring groups having five to fourteen members, including monocyclic heteroaromatic rings and polycyclic aromatic rings

in which a monocyclic aromatic ring is fused to one or more other aromatic ring (carbocyclic or heterocyclic). Heteroaryl groups have one or more ring heteroatoms. Examples of heteroaryl groups include 2-furanyl, 3-furanyl, *N*-imidazolyl, 2-imidazolyl, 4-imidazolyl, 5-imidazolyl, 3-isoxazolyl, 4-isoxazolyl, 5-isoxazolyl, 5 oxadiazolyl, oxadiazolyl, 2-oxazolyl, 4-oxazolyl, 5-oxazolyl, *N*-pyrazolyl, 3-pyrazolyl, 4-pyrazolyl, 5-pyrazolyl, *N*-pyrrolyl, 2-pyrrolyl, 3-pyrrolyl, 2-pyridyl, 3-pyridyl, 4-pyridyl, 2-pyrimidinyl, 4-pyrimidinyl, 5-pyrimidinyl, 3-pyridazinyl, 4-pyridazinyl, 2-thiazolyl, 4-thiazolyl, 5-thiazolyl, triazolyl, tetrazolyl, 2-thienyl, 3-thienyl, carbazolyl, benzothienyl, benzofuranyl, indolyl, quinolinyl, benzothiazole, benzooxazole, benzimidazolyl, isoquinolinyl and isoindolyl. Also included within the scope of the term "heteroaryl", as it is used herein, is a group in which an aromatic ring is fused to one or more non-aromatic rings (carbocyclic or heterocyclic), where the radical or point of attachment is on the aromatic ring.

The term non-aromatic heterocyclic group used alone or as part of a larger moiety refers to non-aromatic heterocyclic ring groups having three to fourteen members, including monocyclic heterocyclic rings and polycyclic rings in which a monocyclic ring is fused to one or more other non-aromatic carbocyclic or heterocyclic ring or aromatic ring (carbocyclic or heterocyclic). Heterocyclic groups have one or more ring heteroatoms, and can be saturated or unsaturated. Examples of heterocyclic groups include piperidinyl, piperizinyl, pyrrolidinyl, pyrazolidinyl, imidazolidinyl, tetrahydroquinolinyl, inodolinyl, isoindolinyl, tetrahydrofuranyl, oxazolidinyl, thiazolidinyl, dioxolanyl, dithiolanyl, tetrahydropyranyl, dihydropyranyl, azepanyl and azetidinyl

The term "heteroatom" means nitrogen, oxygen, or sulfur and includes any oxidized form of nitrogen and sulfur, and the quaternized form of any basic nitrogen. Also the term "nitrogen" includes a substitutable nitrogen of a heteroaryl or non-aromatic heterocyclic group. As an example, in a saturated or partially unsaturated ring having 0-3 heteroatoms selected from oxygen, sulfur or nitrogen, the nitrogen may be N (as in 3,4-dihydro-2*H*-pyrrolyl), NH (as in pyrrolidinyl) or NR" (as in *N*-substituted pyrrolidinyl), wherein R" is a suitable substituent for the nitrogen atom in the ring of a non-aromatic nitrogen-containing heterocyclic group, as defined below.

- 129 -

As used herein the term non-aromatic carbocyclic ring as used alone or as part of a larger moiety refers to a non-aromatic carbon containing ring which can be saturated or unsaturated having three to fourteen atoms including monocyclic and polycyclic rings in which the carbocyclic ring can be fused to one or more non-aromatic carbocyclic or heterocyclic rings or one or more aromatic (carbocyclic or heterocyclic) rings

An optionally substituted aryl group as defined herein may contain one or more substitutable ring atoms, such as carbon or nitrogen ring atoms. Examples of suitable substituents on a substitutable ring carbon atom of an aryl group include halogen (e.g., -Br, Cl, I and F), -OH, C1-C4 alkyl, C1-C4 haloalkyl, -NO₂, C1-C4 alkoxy, C1-C4 haloalkoxy, -CN, -NH₂, C1-C4 alkylamino, C1-C4 dialkylamino, -C(O)NH₂, -C(O)NH(C1-C4 alkyl), -C(O)(C1-C4 alkyl), -OC(O)(C1-C4 alkyl), -OC(O)(aryl), -OC(O)(substituted aryl), -OC(O)(aralkyl), -OC(O)(substituted aralkyl), -NHC(O)H, -NHC(O)(C1-C4 alkyl), -C(O)N(C1-C4 alkyl)₂, -NHC(O)O-(C1-C4 alkyl), -C(O)OH, -C(O)O-(C1-C4 alkyl), -NHC(O)NH₂, -NHC(O)NH(C1-C4 alkyl), -NHC(O)N(C1-C4 alkyl)₂, -NH-C(=NH)NH₂, -SO₂NH₂, -SO₂NH(C1-C3alkyl), -SO₂N(C1-C3alkyl)₂, NHSO₂H, NHSO₂(C1-C4 alkyl) and optionally substituted aryl. Preferred substituents on aryl groups are as defined throughout the specification. In certain embodiments aryl groups are unsubstituted.

Examples of suitable substituents on a substitutable ring nitrogen atom of an aryl group include C1-C4 alkyl, NH₂, C1-C4 alkylamino, C1-C4 dialkylamino, -C(O)NH₂, -C(O)NH(C1-C4 alkyl), -C(O)(C1-C4 alkyl), -CO₂ R**, -C(O)C(O)R**, -C(O)CH₃, -C(O)OH, -C(O)O-(C1-C4 alkyl), -SO₂NH₂, -SO₂NH(C1-C3alkyl), -SO₂N(C1-C3alkyl)₂, NHSO₂H, NHSO₂(C1-C4 alkyl), -C(=S)NH₂, -C(=S)NH(C1-C4 alkyl), -C(=S)N(C1-C4 alkyl)₂, -C(=NH)-N(H)₂, -C(=NH)-NH(C1-C4 alkyl) and -C(=NH)-N(C1-C4 alkyl)₂.

An optionally substituted alkyl group or non-aromatic carbocyclic or heterocyclic group as defined herein may contain one or more substituents.

Examples of suitable substituents for an alkyl group include those listed above for a substitutable carbon of an aryl and the following: =O, =S, =NNHR**, =NN(R**)₂, =NNHC(O)R**, =NNHCO₂ (alkyl), =NNHSO₂ (alkyl), =NR**, spiro cycloalkyl group or fused cycloalkyl group. R** in each occurrence, independently is -H or

- 130 -

C1-C6 alkyl. Preferred substituents on alkyl groups are as defined throughout the specification. In certain embodiments optionally substituted alkyl groups are unsubstituted.

5 A "spiro cycloalkyl" group is a cycloalkyl group which shares one ring carbon atom with a carbon atom in an alkylene group or alkyl group, wherein the carbon atom being shared in the alkyl group is not a terminal carbon atom.

Without wishing to be bound by any theory or limited to any mechanism it is believed that macromolecular antioxidants and polymeric macromolecular antioxidants of the present invention exploit the differences in activities (ks,
10 equilibrium constant) of, for example, homo- or hetero- type antioxidant moieties. Antioxidant moieties include, for example, hindered phenolic groups, unhindered phenolic groups, aminic groups and thioester groups, etc. of which there can be one or more present in each macromolecular antioxidant molecule. As used herein a homo- type antioxidant macromolecule comprises antioxidant moieties which are all
15 same, for example, hindered phenolic, -OH groups. As used herein a hetero- type antioxidant macromolecule comprises at least one different type of moiety, for example, hindered phenolic and aminic groups in the one macromolecule.

This difference in activities can be the result of, for example, the substitutions on neighboring carbons or the local chemical or physical environment
20 (for example, due to electrochemical or stereochemical factors) which can be due in part to the macromolecular nature of molecules.

In one embodiment of the present invention, a series of macromolecular antioxidant moieties of the present invention with different chemical structures can be represented by W1H, W2H, W3H, to WnH. In one embodiment of the
25 present invention, two types of antioxidant moieties of the present invention can be represented by: W1H and W2H. In certain embodiments W1H and W2H can have rate constants of k1 and k2 respectively. The reactions involving these moieties and peroxy radicals can be represented as:

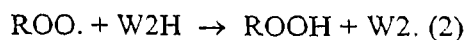

- 131 -

k₂

where ROO \cdot is a peroxy radical resulting from, for example, initiation steps
 5 involving oxidation activity, for example:



10 In one particular embodiment of the present invention $k_1 \gg k_2$ in equations (1) and (2). As a result, the reactions would take place in such a way that there is a decrease in concentration of W₁ free radicals due their participation in the regeneration of active moiety W₂H in the molecule according equation (5):

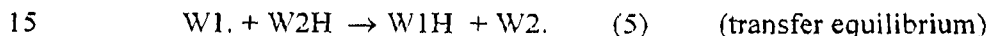

This transfer mechanism may take place either in intra- or inter-molecular macromolecules. The transfer mechanism (5) could take place between moieties residing on the same macromolecule (intra- type) or residing on different
 20 macromolecules (inter-type).

In certain embodiments of the present invention, the antioxidant properties described immediately above (equation 5) of the macromolecular antioxidants and polymeric macromolecular antioxidants of the present invention result in advantages including, but not limited to:

- 25
- a) Consumption of free radicals W₁ according to equation (5) can result in a decrease of reactions of W₁ with hydroperoxides and hydrocarbons (RH).
 - b) The regeneration of W₁H provides extended protection of materials. This is a generous benefit to sacrificial type of antioxidants that are used today.
- 30 Regeneration of W₁H assists in combating the oxidation process. The increase in the concentration of antioxidant moieties W₁H (according to equation 5) extends the shelf life of materials.

In certain embodiments of the present invention, the following items are of significant interest for enhanced antioxidant activity in the design of the macromolecular antioxidants and polymeric macromolecular antioxidants of the present invention:

- a) The activity of proposed macromolecular antioxidant is dependent on the regeneration of W1H in equation (5) either through inter- or intra-molecular activities involving homo- or hetero-type antioxidant moieties.
- b) Depending on the rates constants of W1H and W2H it is possible to achieve performance enhancements by many multiples and not just incremental improvements.

In certain embodiments of the present invention, more than two types of antioxidant moieties with different rate constants are used in the methods of the present invention.

In certain embodiments, the present invention pertains to the use of the disclosed compositions to improve materials, such as lubricants, lubricant oils, compositions comprising lubricants and lubricant oils and mixtures thereof.

In certain embodiments, as defined herein improving a material means inhibiting oxidation of an oxidizable material.

For purposes of the present invention, a method of "inhibiting oxidation" is a method that inhibits the propagation of a free radical-mediated process. Free radicals can be generated by heat, light, ionizing radiation, metal ions and some proteins and enzymes. Inhibiting oxidation also includes inhibiting reactions caused by the presence of oxygen, ozone or another compound capable of generating these gases or reactive equivalents of these gases.

As used herein the term "oxidizable material" is any material which is subject to oxidation by free-radicals or oxidative reaction caused by the presence of oxygen, ozone or another compound capable of generating these gases or reactive equivalents thereof. In particular the oxidizable material is a lubricant or a mixture of lubricants.

In certain other embodiments, as defined herein improving a material means inhibiting oxidation, as well as improving performance and/or increasing the quality

- 133 -

of a material, such as, a lubricant, lubricant oil, composition comprising a lubricant or lubricant oil or mixtures thereof. Increasing the quality of a material includes reducing friction and wear, increasing viscosity, resistance to corrosion, aging or contamination, etc. In certain embodiments, improving means that the lubricant is more resistant to degradation due to the presence of oxygen, temperature, pressure, water, metal species and other contributing factors to degradation. In certain 5 embodiments, additive as described herein help to promote the shelf life of these oils. In certain embodiments the stability of the lubricants is directly related to their performance. That is the lubricant will not perform well if the lubricant has been degraded. In certain embodiments the performance of the lubricants is related to 10 the additives. That is if antioxidant and additives are used they will result in an improvement in the stability and performance of the lubricants.

A lubricant, as defined herein is a substance (usually a liquid) introduced between two moving surfaces to reduce the friction and wear between them. 15 Lubricant can be used in, for example, automotive engines, hydraulic fluids with transmission oils and the like. In addition to automotive and industrial applications, lubricants are used for many other purposes, including bio-medical applications (e.g. lubricants for artificial joints), grease, aviation lubricants, turbine engine lubricants, compressor oils, power transformer oils, automatic transmission fluids, metal 20 working fluids, gear oils, sexual lubricants and others.

Non-liquid lubricants include grease, powders (dry graphite, PTFE, Molybdenum disulfide, etc.), teflon tape used in plumbing, air cushion and others.

The entire teachings of each of the following applications are incorporated herein by reference:

- 25 Docket No.: 3805.1000-000; Provisional Patent Application No.: 60/632,893, filed December 3, 2004, Title: Process For The Synthesis Of Polyalkylphenol Antioxidants, by Suizhou Yang, et al;
- Docket No.: 3805.1000-001; filed December 2, 2005, Title: Process For The Synthesis Of Polyalkylphenol Antioxidants, by Suizhou Yang, et al;
- 30 Docket No.: 3805.1001-000; Provisional Patent Application No.: 60/633,197, filed December 3, 2004, Title: Synthesis Of Sterically Hindered Phenol Based Macromolecular Antioxidants, by Ashish Dhawan, et al.;

- 134 -

- Docket No.: 3805.1001-001; filed December 2, 2005, Title: Synthesis Of Sterically Hindered Phenol Based Macromolecular Antioxidants, by Ashish Dhawan, et al.;
- 5 Docket No.: 3805.1002-000; Provisional Patent Application No.: 60/633,252, filed December 3, 2004, Title: One Pot Process For Making Polymeric Antioxidants, by Vijayendra Kumar, et al.;
- Docket No.: 3805.1002-001; filed December 2, 2005, Title: One Pot Process For Making Polymeric Antioxidants, by Vijayendra Kumar, et al.;
- 10 Docket No.: 3805.1003-000; Provisional Patent Application No.: 60/633,196, filed December 3, 2004, Title: Synthesis Of Aniline And Phenol-Based Macromonomers And Corresponding Polymers, by Rajesh Kumar, et al.;
- Docket No.: 3805.1003-001; filed December 2, 2005, Title: Synthesis Of Aniline And Phenol-Based Macromonomers And Corresponding Polymers, by Rajesh Kumar, et al.;
- 15 Docket No.: 3805.1004-002; Patent Application No.: 11/184,724, filed July 19, 2005, Title: Anti-Oxidant Macromonomers And Polymers And Methods Of Making And Using The Same, by Ashok L. Cholli;
- Docket No.: 3805.1004-005; Patent Application No. 11/184,716, filed July 19, 2005, Title: Anti-Oxidant Macromonomers And Polymers And Methods Of
- 20 Making And Using The Same, by Ashok L. Cholli;
- Docket No.: 3805.1005-000; Provisional Patent Application No.: 60/655,169, filed February 22, 2005, Title: Nitrogen And Hindered Phenol Containing Dual Functional Macromolecules: Synthesis And Their Antioxidant Performances In Organic Materials, by Rajesh Kumar, et al.
- 25 Docket No.: 3805.1006-000; Provisional Patent Application No.: 60/655,638, filed March 25, 2005, Title: Alkylated Macromolecular Antioxidants And Methods Of Making, And Using The Same, by Rajesh Kumar, et al.
- Docket No.: 3805.1007-000; Provisional Patent Application No. 60/731,125, filed
- 30 October 27, 2005, Title: Macromolecular Antioxidants And Polymeric Macromolecular Antioxidants, by Ashok L. Cholli, et al.

- 135 -

- Docket No.: 3805.1008-000; Provisional Patent Application No. 60/731,021, filed October 27, 2005, Title: , Title: Macromolecular Antioxidants Based On Sterically Hindered Phenols And Phosphites, by Ashok L. Cholli, et al.
- 5 Docket No.: 3805.1010-000; Provisional Patent Application No. 60/731,325, filed October 27, 2005, Title: , Title: Stabilized Polyolefin Composition, by Kumar, Rajesh, et al.
- Docket No.: 0813.2006-003; Patent Application No.: 11/040,193, filed January 21 2005, Title: Post-Coupling Synthetic Approach For Polymeric Antioxidants, by Ashok L. Choll, et al.;
- 10 Docket No.: 0813.2006-002; Patent Application No.: PCT/US2005/001948, filed January 21, 2005, Title: Post-Coupling Synthetic Approach For Polymeric Antioxidants, by Ashok L. Cholli et al.;
- Docket No.: 0813.2002-008; Patent Application No.: PCT/US2005/001946, filed January 21 2005, Title: Polymeric Antioxidants, by Ashok L. Choll, et al.;
- 15 Docket No.: 0813.2002-003; Patent Application No.: PCT/US03/10782, filed April 4, 2003, Title: Polymeric Antioxidants, by Ashok L. Choll, et al.;
- Docket No.: 0813.2002-004; Patent Application No.: 10/761,933, filed January 21, 2004, Title: Polymeric Antioxidants, by Ashish Dhawan, et al.;
- 20 Docket No.: 0813.2002-001; Patent Application No.: 10/408,679, filed April 4, 2003, Title: Polymeric Antioxidants, by Ashok L. Choll, et al.;
- Tertiary Butoxy Derivatives of Phenol. (Jan Pospisil and Ludek Taimr). (1964), 2 pp. CS 111291
- A New Synthesis of aryl tert-butyl Ethers. Masada, Hiromitsu; Oishi, Yutaka. Fac. Eng., Kanazawa Univ., Kanazawa, Japan. Chemistry Letters (1978), (1), 57-
25 8.
- Simple Synthesis of the tert-butyl Ether of Phenol. Ol'dekop, Yu. A.; Maier, N. A.; Erdman, A. A.; Shirokii, V. L.; Zubreichuk, Z. P.; Beresnevich, L. B. Inst. Fiz.-Org. Khim., Minsk, USSR. Zhurnal Obshchei Khimii (1980), 50(2), 475-6.

- 136 -

- New Method for the Williamson Ether Synthesis Using tert-alkyl Halides in Nonpolar Solvents. Masada, Hiromitsu; Mikuchi, Fumio; Doi, Yasuo; Hayashi, Akira. Dep. Chem. Chem. Eng., Kanazawa Univ., Kanazawa, Japan. *Nippon Kagaku Kaishi* (1995), (2), 164-6.
- 5 New Heterogeneous Williamson Synthesis of Ethers Using tert-alkyl Substrates. Masada, Hiromitsu; Doi, Yasuo; Mikuchi, Fumio; Keiko, Kigoshi. Faculty Eng., Kanazawa Univ., Kanazawa, Japan. *Nippon Kagaku Kaishi* (1996), (3), 275-82.
- Preparation of Aromatic Tertiary Ethers. Tanaka, Masato; Reddy, Nagaveri
10 Prabacal. (Agency of Industrial Sciences and Technology, Japan). *Jpn. Kokai Tokkyo Koho* (1999), 3 pp. JP 080063.
- Preparation of Aromatic Ethers. Watanabe, Makoto; Koie, Yasuyuki. (Tosoh Corp., Japan). *Jpn. Kokai Tokkyo Koho* (1999), 10 pp. JP 11158103.
- o-Alkylated phenols. Firth, Bruce E.; Rosen, Terry J. (UOP Inc., USA). U.S. 4447657 (1984), 4 pp.
15
- 2-Tert-Butyl-4-alkoxy- and -4-hydroxyphenols. Firth, Bruce E.; Rosen, Terry J. (UOP Inc., USA). U.S. 4465871 (1984), 4 pp.
- Conversion of Alkyl Phenyl Ether to Alkylphenol. Klicker, James D. (Borg-Warner Corp., USA). U.S. 4283572 (1981), 3 pp.
- 20 O.N.Tsevtov, K.D.Kovenev, *Int. J. Chem. Eng.* 6 (1966), 328.
- Sartori Giovanni, Franca Bigi et al., *Chem. Ind.* (London), 1985 (22) 762-763.
- V.A. Koshchii, Ya.B Kozlikovskii, A.A Matyusha, *Zh. Org. Khim.* 24(7), 1988, 1508-1512.
- Gokul K. Chandra, M.M.Sharma, *Catal. Lett.* 19(4), 1993, 309-317.
- 25 Sakthivel, Ayyamperumal; Saritha, Nellutla; Selvam, Parasuraman, *Catal. Lett.* 72(3), 2001, 225-228.
- V. Quaschnig, J. Deutsch, P. Druska, H.J. Niclas and E. Kemnitz. *J. Catal.* 177 (1998), p. 164.
- S.K. Badamali, S. Sakthivel and P. Selvam. *Catal. Today* 63 (2000), p. 291.
- 30 A. Heidekum, M. A. Hamm and F. Hoelderich. *J. Catal.* 188 (1999), p. 230.
- Y. Kamitori, M. Hojo, R. Matsuda, T. Izumi and S. Tsukamoto. *J. Org. Chem.* 49 (1984), p. 4165.

E. Armengol, A. Corma, H. García and J. Primo. *Appl. Catal. A* 149 (1997), p. 411.

J.M. Lalancette, M.J. Fournier and R. Thiffault. *Can. J. Chem.* 52 (1974), p. 589.

Japanese Patent No. JP 145002980, 1970.

Japanese Patent No. 44028850, 1969.

5 Japanese Patent No. 44024274, 1969.

EXEMPLIFICATION

Example 1,

10 A commercial lubricant oil (example Castrol GTX 5W30) which comprises additives, was added to a known amount of a first antioxidant as described above.

The commercial lubricant oil alone was tested versus the commercial lubricant oil with the added antioxidant, using Passenger Car Motor Oil (PMCO) TEOST MHT test (ASTM D78097-05 test) performed at SWRI, Antonio Texas.

15 Test conditions include 285 °C for 24 hours, airflow, the deposit on the rod was then tested.

The deposit on the metal strip for the control sample was 46 mg, while for the sample containing the antioxidant was 18 mg. The difference of 28.1 mg was due to 1% of the antioxidant. The smaller deposit on the metal strip indicates the superior performance of the lubricant oil in combination with an antioxidant

20

While this invention has been particularly shown and described with references to preferred embodiments thereof, it will be understood by those skilled in the art that various changes in form and details may be made therein without departing from the scope of the invention encompassed by the appended claims.

CLAIMS

What is claimed is:

1. A composition comprising:
 - a) a first antioxidant; and
 - b) at least one first additive selected from the group consisting of:
 - i) a surface additive;
 - ii) a performance enhancing additive; and
 - iii) a lubricant protective additive.
2. The composition of Claim 1, wherein the first antioxidant is selected from the group consisting of polyalkyl phenol based antioxidants, sterically hindered phenol based antioxidants, sterically hindered phenol based macromolecular antioxidants, nitrogen and hindered phenol containing dual functional macromolecular antioxidants, alkylated macromolecular antioxidants, sterically hindered phenol and phosphite based macromolecular antioxidants.
3. The composition of Claim 2 wherein the first additive is a surface additive selected from the group consisting of (a) rust inhibitors, (b) corrosion inhibitors, (c) extreme pressure agents, (d) tackiness agents, (e) antiwear agents, (f) detergents and dispersants and (g) compounded oil.
4. The composition of Claim 2 wherein the first additive is a performance enhancing additive selected from the group consisting of (a) pour-point depressants, (b) viscosity index modifiers, (c) emulsifiers, and (d) demulsifiers.
5. The composition of Claim 2 wherein the additive is a lubricant protective additive selected from the group consisting of (a) oxidation inhibitors and (b) foam inhibitors.

- 5 6. The composition of Claim 2 wherein the composition further includes at least one second additive selected from the group consisting of: dispersants, detergents, corrosion inhibitors, rust inhibitors, metal deactivators, antiwear and extreme pressure agents, antifoam agents, friction modifiers, seal swell agents, demulsifiers, viscosity index improvers and pour point depressants.
- 10 7. The composition of Claim 6 wherein the composition further includes a second antioxidant selected from the group consisting of: amine antioxidants, phenolic antioxidants, sulfurized organic compounds, organo-borate compounds, phosphite and phosphate antioxidants, copper compounds and zinc dithiodiphosphates.
- 15 8. A lubricant composition comprising:
a) a lubricant or a mixture of lubricants;
b) a first antioxidant; and
c) at least one first additive selected from the group consisting of
20 i) a surface additive;
ii) a performance enhancing additive; and
iii) a lubricant protective additive.
- 25 9. The lubricant composition of Claim 8, wherein the first antioxidant is selected from the group consisting of polyalkyl phenol based antioxidants, sterically hindered phenol based antioxidants, sterically hindered phenol based macromolecular antioxidants, nitrogen and hindered phenol containing dual functional macromolecular antioxidants, alkylated macromolecular antioxidants, sterically hindered phenol and phosphite based macromolecular antioxidants.
- 30 10. The lubricant composition of Claim 8, wherein the first additive is a surface additive selected from the group consisting of (a) rust

- 140 -

inhibitors, (b) corrosion inhibitors, (c) extreme pressure agents, (d) tackiness agents, (e) antiwear agents, (f) detergents and dispersants and (g) compounded oil.

- 5 11. The lubricant composition of Claim 10, wherein the antioxidant is in a concentration range from about 0.0001% to about 50%, and the first additive is in a concentration range from about 0.0005% to about 50%, by weight.
- 10 12. The lubricant composition of Claim 8, wherein the first additive is a performance enhancing additive selected from the group consisting of (a) pour-point depressants, (b) viscosity index modifiers, (c) emulsifiers, and (d) demulsifiers.
- 15 13. The lubricant composition of Claim 12, wherein the antioxidant is in a concentration range from about 0.0001% to about 50%, and the first additive is in a concentration range from about 0.0005% to about 50%, by weight.
- 20 14. The lubricant composition of Claim 8, wherein the additive is a lubricant protective additive selected from the group consisting of (a) oxidation inhibitors and (b) foam inhibitors.
- 25 15. The lubricant composition of Claim 14, wherein the antioxidant is in a concentration range from about 0.0001% to about 50%, and the first additive is in a concentration range from about 0.0005% to about 50%, by weight.
- 30 16. The lubricant composition of Claim 8, wherein the composition further includes at least one second additive selected from the group consisting of: dispersants, detergents, corrosion inhibitors, rust inhibitors, metal deactivators, antiwear and extreme pressure agents,

antifoam agents, friction modifiers, seal swell agents, demulsifiers, viscosity index improvers and pour point depressants.

- 5 17. The lubricant composition of Claim 16, wherein the composition further includes a second antioxidant selected from the group consisting of: amine antioxidants, phenolic antioxidants, sulfurized organic compounds, organo-borate compounds, phosphite and phosphate antioxidants, copper compounds and zinc dithiodiphosphates.
- 10 18. The lubricant composition of Claim 8, wherein the lubricant is selected from the group comprising petroleum based oils, synthetic oils and biolubricant oils.
- 15 19. A method of improving a composition comprising combining the composition with:
- a) a first antioxidant; and
 - b) at least one first additive selected from the group consisting of:
 - 20 i) a surface additive;
 - ii) a performance enhancing additive; and
 - iii) a lubricant protective additive.
- 25 20. The method of Claim 19, wherein the first antioxidant is selected from the group consisting of polyalkyl phenol based antioxidants, sterically hindered phenol based antioxidants, sterically hindered phenol based macromolecular antioxidants, nitrogen and hindered phenol containing dual functional macromolecular antioxidants, alkylated macromolecular antioxidants, sterically hindered phenol
- 30 and phosphite based macromolecular antioxidants.

- 142 -

21. A method of improving a lubricant or a mixture of lubricants comprising combining the lubricant or mixture of lubricants with:
- a) a first antioxidant; and
 - b) at least one first additive selected from the group consisting of:
 - i) a surface additive;
 - ii) a performance enhancing additive; and
 - iii) a lubricant protective additive.
22. The method of Claim 21, wherein the first antioxidant is selected from the group consisting of polyalkyl phenol based antioxidants, sterically hindered phenol based antioxidants, sterically hindered phenol based macromolecular antioxidants, nitrogen and hindered phenol containing dual functional macromolecular antioxidants, alkylated macromolecular antioxidants, sterically hindered phenol and phosphite based macromolecular antioxidants.
23. The method of Claim 22, wherein the first additive is a surface additive selected from the group consisting of (a) rust inhibitors, (b) corrosion inhibitors, (c) extreme pressure agents, (d) tackiness agents, (e) antiwear agents, (f) detergents and dispersants and (g) compounded oil.
24. The method of Claim 23, wherein the antioxidant is in a concentration range from about 0.0001% to about 50%, and the first additive is in a concentration range from about 0.0005% to about 50%, by weight.
25. The method of Claim 22, wherein the first additive is a performance enhancing additive selected from the group consisting of (a) pour-point depressants, (b) viscosity index modifiers, (c) emulsifiers, and (d) emulsifiers.

- 5 26. The method of Claim 25, wherein the antioxidant is in a concentration range from about 0.0001% to about 50%, and the first additive is in a concentration range from about 0.0005% to about 50%, by weight.
- 10 27. The method of Claim 22, wherein the additive is a lubricant protective additive selected from the group consisting of (a) oxidation inhibitors and (b) foam inhibitors.
- 15 28. The method of Claim 27, wherein the antioxidant is in a concentration range from about 0.0001% to about 50%, and the first additive is in a concentration range from about 0.0005% to about 50%, by weight.
- 20 29. The method of Claim 22, wherein the composition further includes at least one second additive selected from the group consisting of: dispersants, detergents, corrosion inhibitors, rust inhibitors, metal deactivators, antiwear and extreme pressure agents, antifoam agents, friction modifiers, seal swell agents, demulsifiers, viscosity index improvers and pour point depressants.
- 25 30. The method of Claim 29, wherein the composition further includes a second antioxidant selected from the group consisting of: amine antioxidants, phenolic antioxidants, sulfurized organic compounds, organo-borate compounds, phosphite and phosphate antioxidants, copper compounds and zinc dithiodiphosphates.
- 30 31. The method of Claim 22, wherein the lubricant is selected from the group comprising petroleum based oils, synthetic oils and biolubricant oils.

INTERNATIONAL SEARCH REPORT

International application No
PCT/US2006/045929

A. CLASSIFICATION OF SUBJECT MATTER

INV. C10M161/00
ADD. C10N30/10 C10N60/00

According to International Patent Classification (IPC) or to both national classification and IPC

B. FIELDS SEARCHED

Minimum documentation searched (classification system followed by classification symbols)
C10M C08F C09K C08K

Documentation searched other than minimum documentation to the extent that such documents are included in the fields searched

Electronic data base consulted during the international search (name of data base and, where practical, search terms used)

EPO-Internal, COMPENDEX, WPI Data

C. DOCUMENTS CONSIDERED TO BE RELEVANT

Category*	Citation of document, with indication, where appropriate, of the relevant passages	Relevant to claim No.
X	US 2003/030033 A1 (DUYCK KARL J [US] ET AL) 13 February 2003 (2003-02-13) paragraphs [0050], [0139], [0158], [0159], [0167], [0168], [0170]; claims 1-47	1-31
X	US 5 834 544 A (LIN CHUNG-YUAN [US] ET AL) 10 November 1998 (1998-11-10) column 1, line 8 - line 12 column 3, line 2 - line 5 column 6, line 45 - column 7, line 7; claims 1-33; examples 1,8; table 6	1-31
X	US 3 996 160 A (DALE JAMES A ET AL) 7 December 1976 (1976-12-07) claims 1-24; examples I-IX; table III	1-3, 19, 20
	----- -/--	

 Further documents are listed in the continuation of Box C. See patent family annex.

* Special categories of cited documents :

- *A* document defining the general state of the art which is not considered to be of particular relevance
- *E* earlier document but published on or after the international filing date
- *L* document which may throw doubts on priority claim(s) or which is cited to establish the publication date of another citation or other special reason (as specified)
- *O* document referring to an oral disclosure, use, exhibition or other means
- *P* document published prior to the international filing date but later than the priority date claimed

- *T* later document published after the international filing date or priority date and not in conflict with the application but cited to understand the principle or theory underlying the invention
- *X* document of particular relevance; the claimed invention cannot be considered novel or cannot be considered to involve an inventive step when the document is taken alone
- *Y* document of particular relevance; the claimed invention cannot be considered to involve an inventive step when the document is combined with one or more other such documents, such combination being obvious to a person skilled in the art.
- *&* document member of the same patent family

Date of the actual completion of the international search

12 April 2007

Date of mailing of the international search report

20/04/2007

Name and mailing address of the ISA/

European Patent Office, P.B. 5818 Patentlaan 2
NL - 2280 HV Rijswijk
Tel. (+31-70) 340-2040, Tx. 31 651 epo nl,
Fax: (+31-70) 340-3016

Authorized officer

Glod, Guy

INTERNATIONAL SEARCH REPORT

International application No

PCT/US2006/045929

C(Continuation). DOCUMENTS CONSIDERED TO BE RELEVANT

Category*	Citation of document, with indication, where appropriate, of the relevant passages	Relevant to claim No.
X	US 2003/230743 A1 (CHOLLI ASHOK L [US] ET AL) 18 December 2003 (2003-12-18) paragraph [0075]; claims 1-40; example 5 -----	1-31
X	US 2005/238789 A1 (CHOLLI ASHOK L [US] ET AL) 27 October 2005 (2005-10-27) paragraph [0085]; claims 1-18; examples 1-9 -----	1-31
X	DE 197 47 644 A1 (INST POLYMERFORSCHUNG DRESDEN [DE]) 6 May 1999 (1999-05-06) column 4, line 68 - column 5, line 6; claims 1-13 -----	1-31
P,X	WO 2006/018403 A (CIBA SC HOLDING AG [CH]; AL-AKHDAR WALID [US]; CHAFIN LAURA F [IT]; CH) 23 February 2006 (2006-02-23) claims 1-9 -----	1-31
A	US 5 013 470 A (BENFAREMO NICOLAS [US]) 7 May 1991 (1991-05-07) claims 1-9; example I -----	1-31
A	GB 1 283 103 A (CIBA GEIGY AG [CH]) 26 July 1972 (1972-07-26) page 1, line 5 - line 12; claims 1-11 -----	1-31

INTERNATIONAL SEARCH REPORT

Information on patent family members

International application No

PCT/US2006/045929

Patent document cited in search report	Publication date	Patent family member(s)	Publication date
US 2003030033	A1	13-02-2003	NONE
US 5834544	A	10-11-1998	CA 2307106 A1 29-04-1999 EP 1030832 A2 30-08-2000 JP 2001520239 T 30-10-2001 WO 9920686 A2 29-04-1999
US 3996160	A	07-12-1976	AU 507434 B2 14-02-1980 AU 1131876 A 01-09-1977 CA 1093744 A1 13-01-1981 DE 2607431 A1 26-08-1976 IL 49084 A 30-11-1979 JP 971407 C 27-09-1979 JP 51110000 A 29-09-1976 JP 54003798 B 27-02-1979 JP 54039499 A 26-03-1979 NL 7601782 A 26-08-1976 ZA 7601104 A 23-02-1977
US 2003230743	A1	18-12-2003	US 2006029706 A1 09-02-2006 US 2004214935 A1 28-10-2004
US 2005238789	A1	27-10-2005	NONE
DE 19747644	A1	06-05-1999	SK 145198 A3 12-03-2001
WO 2006018403	A	23-02-2006	AU 2005273923 A1 23-02-2006 CA 2575502 A1 23-02-2006
US 5013470	A	07-05-1991	NONE
GB 1283103	A	26-07-1972	CA 969192 A1 10-06-1975 DE 1931452 A1 08-01-1970 ES 368587 A1 01-05-1971 FR 2011412 A5 27-02-1970 JP 48038463 B 17-11-1973 NL 6909496 A 23-12-1969