

(19) World Intellectual Property Organization
International Bureau



(43) International Publication Date
20 June 2002 (20.06.2002)

PCT

(10) International Publication Number
WO 02/47563 A1

- (51) International Patent Classification⁷: **A61B 17/34**,
A61F 2/46, 2/44 **AHERN, James, W.**; 126 11th Avenue North, Hopkins,
MN 55343 (US).
- (21) International Application Number: PCT/US01/41256 (74) Agent: **VIDAS, Scott, Q.**; Vidas, Arrett & Steinkraus,
Suite 2000, 6109 Blue Circle Drive, Minnetonka, MN
55343-9185 (US).
- (22) International Filing Date: 3 July 2001 (03.07.2001)
- (25) Filing Language: English (81) Designated States (*national*): AU, CA, HU, JP, KR, NZ.
- (26) Publication Language: English (84) Designated States (*regional*): European patent (AT, BE,
CH, CY, DE, DK, ES, FI, FR, GB, GR, IE, IT, LU, MC,
NL, PT, SE, TR).
- (30) Priority Data:
09/738,726 15 December 2000 (15.12.2000) US **Published:**
— with international search report
— before the expiration of the time limit for amending the
claims and to be republished in the event of receipt of
amendments
- (71) Applicant: **THE SPINEOLOGY GROUP, LLC.**
[US/US]; 1815 Northwestern Avenue, Stillwater, MN
55082 (US).
- (72) Inventors: **KUSLICH, Stephen, D.**; 10343 Dellwood
Road North, Stillwater, MN 55082 (US). **PETERSON,**
Francis; 807 College Street, Prescott, WI 54021 (US). *For two-letter codes and other abbreviations, refer to the "Guidance Notes on Codes and Abbreviations" appearing at the beginning of each regular issue of the PCT Gazette.*

(54) Title: TOOL TO DIRECT BOND REPLACEMENT MATERIAL

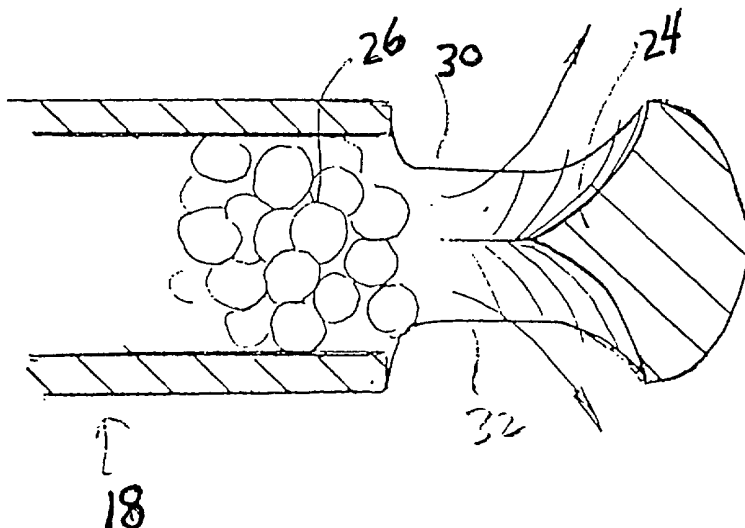

(57) Abstract: A fill tool (18) for directing bone replacement material (26) into an expandable bag within a reamed out disc includes a deflector (24) at its distal end which deflects the flow of such material to a one or more side openings (30, 32) at the distal end of the fill tool (18). This allows the tool to be used without being ejected when filling the bag under pressure and greatly increases the distraction forces possible when filling the bag.



WO 02/47563 A1

TOOL TO DIRECT BOND REPLACEMENT MATERIAL

CROSS-REFERENCE TO RELATED APPLICATIONS

This application is a continuation-in-part (CIP) of Serial Number 09/608,079 filed June 30, 2000.

5 STATEMENT REGARDING FEDERALLY SPONSORED RESEARCH OR DEVELOPMENT

Not Applicable.

BACKGROUND OF THE INVENTION

10 This invention relates to a tool for use injecting bone replacement material into a cavity within a bone, especially when the cavity includes a bag which is to be inflated within the cavity.

U.S. Patents 5,549,679 issued August 20, 1996 and 5,571,189 which issued November 5, 1996 disclose an expandable fabric bag and method for stabilizing a
15 spinal motion segment. In those patents, a damaged disc is reamed out and an expandable fabric bag is inserted into the cavity thus formed. Bone graft material is then inserted into the bag to fill and expand the bag such that the filled bag will take the place of the reamed out disc. Over time, the material within the bag will cause stabilization by either fibrous or bony fusion or a combination of these between the adjacent vertebrae.

20 The bag filling is through an opening which is closed off after filling.

The art described in this section is not intended to constitute an admission that any patent, publication or other information referred to herein is "prior art" with respect to this invention, unless specifically designated as such. In addition, this section should not be construed to mean that a search has been made or that no other pertinent
25 information as defined in 37 C.F.R. § 1.56(a) exists.

BRIEF SUMMARY OF THE INVENTION

The invention provides a tool which dramatically increases the distraction forces within an expandable fabric bag held within a reamed out disc. Distraction
30 consists of a force that is perpendicular to the long axis of the injection tube, thereby producing distraction or increased separation distance between the bony structures that

are perpendicular to the long axis of the injection tube. This allows the spacing between the vertebrae to be adjusted by inflating the bag as desired. The tool may be used in connection with any surgical application in which graft material is to be deployed and is not limited to use in connection with discs or where bags are required.

5

BRIEF DESCRIPTION OF THE DRAWINGS

A detailed description of the invention is hereafter described with specific reference being made to the drawings in which:

FIG. 1 is a perspective view of a distal end of a filling tool of the
10 invention;

FIG. 2 is a side elevational view of the distal end of the tool of FIG. 1;

FIG. 3 is a cross-sectional view of the distal end of the filling tool of the invention showing bone material therewithin;

FIG. 4 is a cross-sectional view of a bag to be filled showing the filling
15 tool inserted into the bag opening;

FIG. 5 is a perspective view of a distal end of an alternate filling tool of the invention;

FIG. 6 is a side elevational view of the distal end of the tool of FIG. 5;

FIG. 7 is a top view of the opening at the distal end of the tool of FIG. 5;

FIG. 8 is a representation of the effects of temperature change on the filled
20 tubes of the invention showing a filled tube in cross-section;

FIG. 9 is a perspective view of a graft insertion tool suitable for use with inserting a band;

FIG. 10 is a side view of the tool shown in FIG. 9;

FIG. 11 is a top down view of the tool of FIG. 9;

FIG. 12 is a side view of the tool of FIG. 9 seen dislocating the fibers of a
band; and

FIG. 13 is a top down cut away view of the tool of FIG. 9 as may be seen
during graft insertion.

30

DETAILED DESCRIPTION OF THE INVENTION

U.S. Patents 5,571,189 and 5,549,679 are incorporated herein by reference. They show an expandable fabric bag which is to be inflated within a reamed out disc space by introduction of bone replacement material through the bag opening. As shown in FIG. 4, bag 10 of the patents is a fabric bag having an opening 12. The opening 12 may be closed off by any number of methods. It has been found that insertion of the bone graft material into the bag may result in low distraction forces and may allow the fill tube to be blown back out of the bag opening when fill pressure is increased.

10 The bone replacement material might be one or more of the following, or any other biocompatible material judged to have the desired physiologic response:

A) Morselized bone graft, cortical, cancellous, or cortico-cancellous, including autograft, allograft, or xenograft.

15 B) Any bone graft substitute or combination of bone graft substitutes, or combinations of bone graft and bone graft substitutes, or bone inducing substances, including but not limited to:

Hydroxyapatite

Bone morphogenic protein

Calcified or decalcified bone derivative

20 C) Bone cements, such as ceramic and polymethylmethacrylate bone cements.

The inventive fill tool 18 of FIGS. 1-4 involves an elongated hollow tube 20 having a proximal end which is attached to a source of bone replacement material under pressure and a distal end 22 which includes the inventive features. As seen, the distal end 22 includes a deflector 24 which deflects flow of bone replacement material 26 out the side openings 30, 32 at an angle. One or more side openings 30, 32 may be present. The deflector 24 as shown in FIG. 3 includes two side openings 30, 32 and the deflector is basically a tapered wedge which diverts flow outwardly to both sides. If only a single side opening is present, the deflector would deflect all flow to that side opening.

30 As shown in FIG. 4, a single side opening 30 allows deflection of the bone replacement material into the expandable fabric bag 10 at an angle relative to the longitudinal axis of the filling tool such that internal forces building up within the bag do

not cause the tool 18 to be ejected out along its longitudinal axis. Rather, any forces inside the bag are exerted back on the sides of the tool 18 against the side walls of the bag, preventing ejection of the tool 18 and allowing more pressure to be applied within the bag 10.

5 The forces during filling provided by the device are perpendicular to the axis of the tube to stop tear through, to prevent the tube from being pushed out during filling, to direct the flow to get the distraction desired and to reduce the overall forces required. A straight tube with an open end has no distraction forces perpendicular to the tube and merely lays a long column of replacement material that needs to buckle before
10 more material can be extruded from the tube. The inventive device breaks up the column of replacement material in the tube by cantilever forces. A straight tube with an open end creates a rigid bar of replacement material that can break a containment bag or damage body structures they press against or cause the tube to be ejected from the neck of the bag or body cavity opening.

15 FIGS. 5 - 7 show an alternative fill tube 40 having a single side opening 30. As shown, the apex 42 is partially closed and the tube is angled toward the apex 42 to help guide and direct the material within the tube out to the side opening 30.

 Tests show a dramatic increase in distraction forces for filling a bag with a tool of the invention in comparison to a fill tool which has an opening in line with its
20 longitudinal axis. Since bone replacement material tends to become quite rigid under pressure, injection of bone replacement material into the bag at an angle relative to the longitudinal axis of the fill tube allows the bag to inflate and create forces which are not directed to eject the fill tool.

 If the internal diameter of the tube is D , the length of the side opening 30
25 is preferably between about $1\frac{1}{2}$ to $3D$. If the side opening 30 length is only $1D$ or smaller, harder pushing is required and packing of the material may result in the tube. The distal end of the tube 40 towards the apex 42 is also preferably angled to direct the flow and to break down any material that has packed back into more discrete pieces. The end adjacent the apex 42 of the tool may be completely closed or open up to $\frac{1}{2}D$ which
30 still provides good side direction of product.

 FIG. 8 depicts a filled tube 20, 40 of the invention which has been filled

with bone replacement material 26. The invention contemplates cooling the tubes prior to use and warming them just prior to use such that expansion of the metal tube causes expansion to help decrease friction to the tube. In addition, if thawing occurs at the metal interface with the bone replacement material, a liquid layer will be formed to lubricate the replacement material within the tube. This allows easier egress of material within the tube.

As may be seen in FIG. 9, the tool may also be used to insert a single walled band into a cavity formed in a spinal disc as disclosed in co-pending U.S. Patent Application entitled *Expandable Tube for Spinal Stabilization*, to Kuslich, and is filed concurrently herewith. The entire contents of the aforementioned concurrently filed application is incorporated herein by reference. As shown in FIG. 12 and 13, the band is shown with a graft insertion tool 60 being inserted into the interior 52 of the band 50 by passing through one of the spaces or pores 54. The shape of the tool 60 as may best be seen in FIGS. 9-11 is essentially an elongate shaft 62 having a tapered or pointed distal end 64.

The tapered distal end 64 of the tool 60 is sized to enlarge the opening 54 to allow passage of the tool 60 into the interior 52 by pushing aside the various fibers 56 as may best be seen in FIG. 12. The fibers 56 are disposed to open the pore 54 from its nominal diameter of 0.25 to 5 mm to an enlarged opening sufficient to allow passage of a portion of the shaft 62 therethrough

The extent of tool penetration into the band interior 52 must be sufficient to allow the side opening 66 to be fully contained within the band interior 52. The tool 60 may include more than one side opening 66.

As shown in FIG. 13, the side opening 66 allows insertion of the bone graft material into the band interior 52. The tool 60 includes a means for pushing graft material from within the shaft 62, through the side opening 66 and into the band interior 52.

While this invention may be embodied in many different forms, there are shown in the drawings and described in detail herein specific preferred embodiments of the invention. The present disclosure is an exemplification of the principles of the invention and is not intended to limit the invention to the particular embodiments

illustrated. For example, the inventive device and methods may be used whenever replacement material needs to be directed into a defined location and not just when a bag is to be filled within a disc cavity.

This completes the description of the preferred and alternate embodiments
5 of the invention. Those skilled in the art may recognize other equivalents to the specific embodiment described herein which equivalents are intended to be encompassed by the claims attached hereto.

CLAIMS:

1. A tool for directing bone replacement material into a defined space comprising:
 - a) an elongated hollow tube having a proximal and a distal end, said proximal end being adapted for attachment to a source of bone replacement material
- 5 under pressure; and
 - b) said distal end including at least one deflector opening for deflecting bone replacement material out of said tube at an angle relative to a longitudinal axis of said tube.
- 10 2. The tool of claim 1 wherein each said deflector opening has a length of between about $1 \frac{1}{2}$ to 3 D, wherein D is the diameter of said tube.
3. The tool of claim 1 wherein each said deflector opening includes a deflector for deflecting bone replacement material from said tube through said deflector opening.
- 15 4. The tool of claim 3 including two opposing deflector openings and said deflector is a tapered wedge adjacent the distal end of said tube.
5. The tool of claim 3 including a single deflector opening and said deflector
- 20 presents an angled ramp to said deflector opening.
6. The tool of claim 5 wherein said distal end of said tube is closed or open up to $\frac{1}{2}$ D, wherein D is the diameter of said tube.

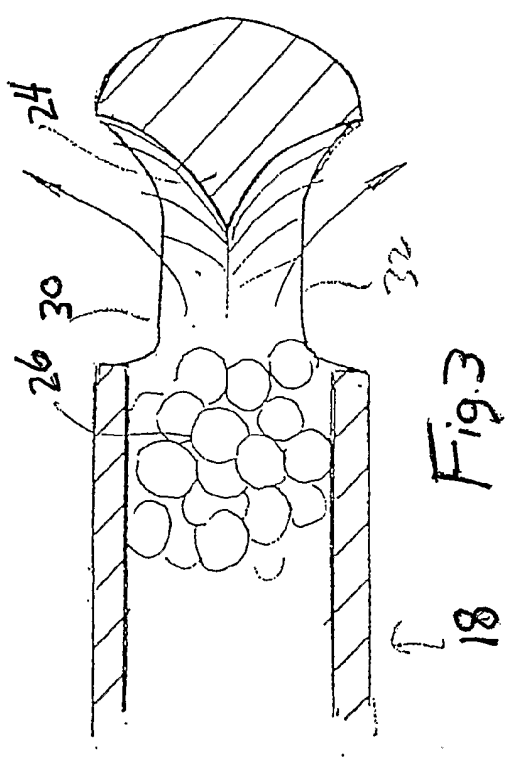
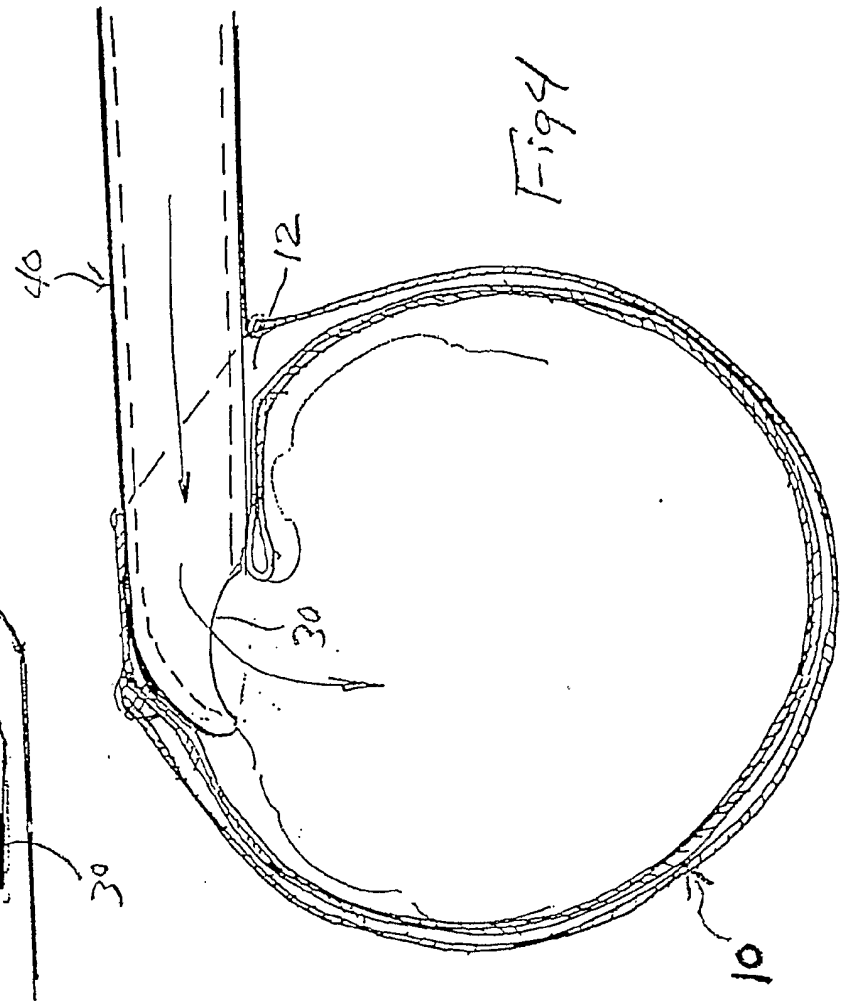
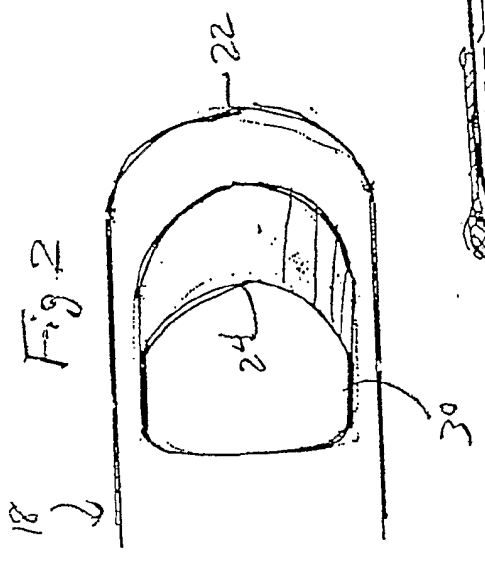
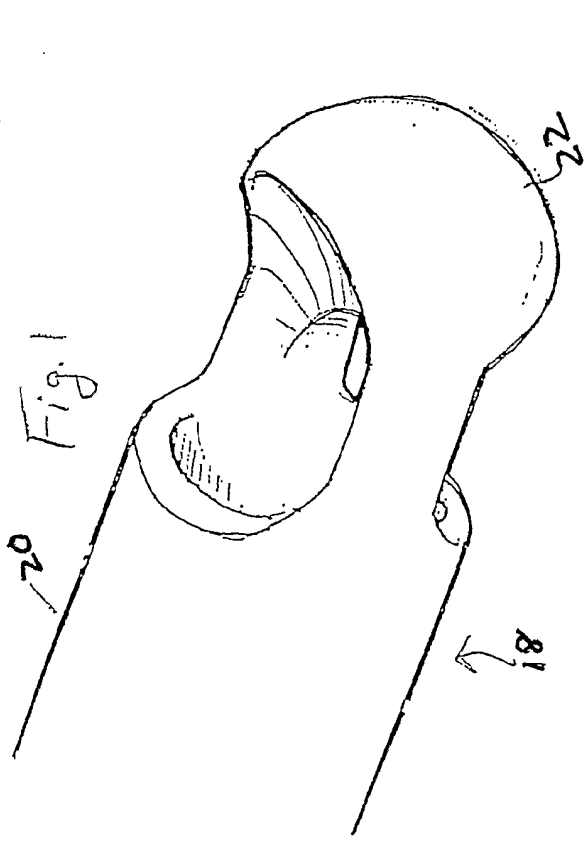

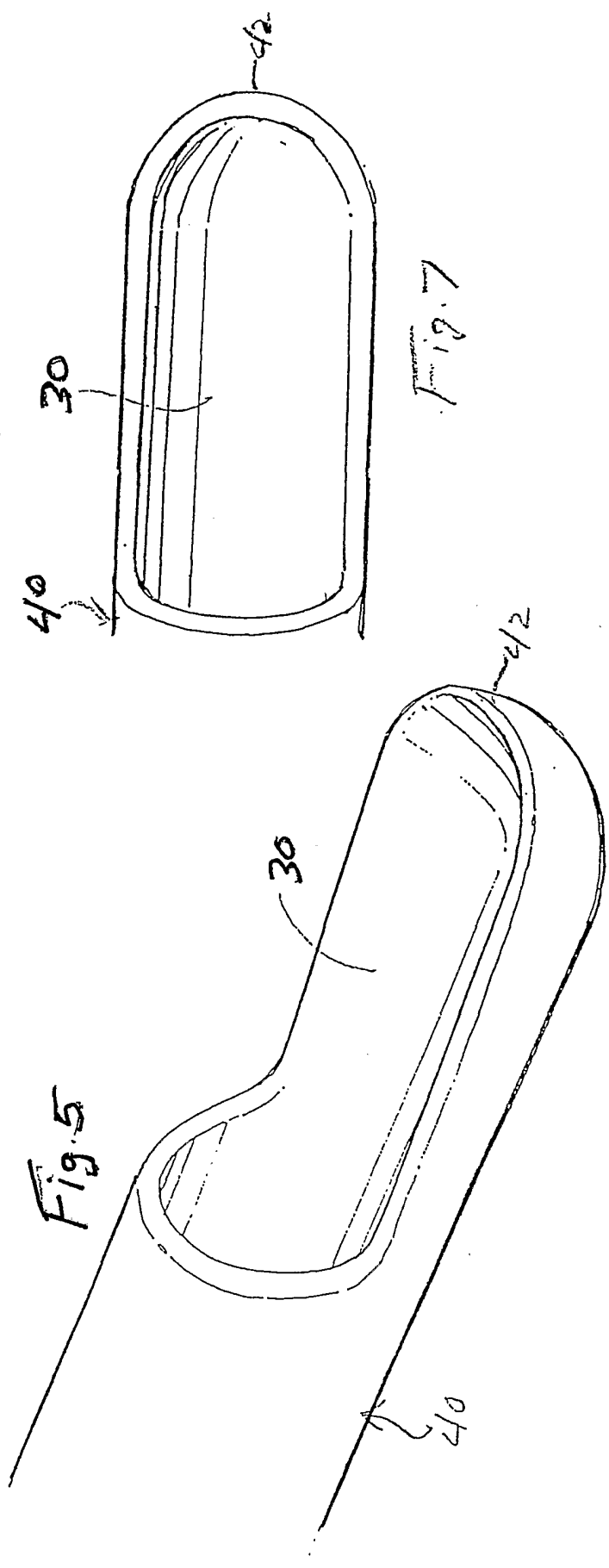
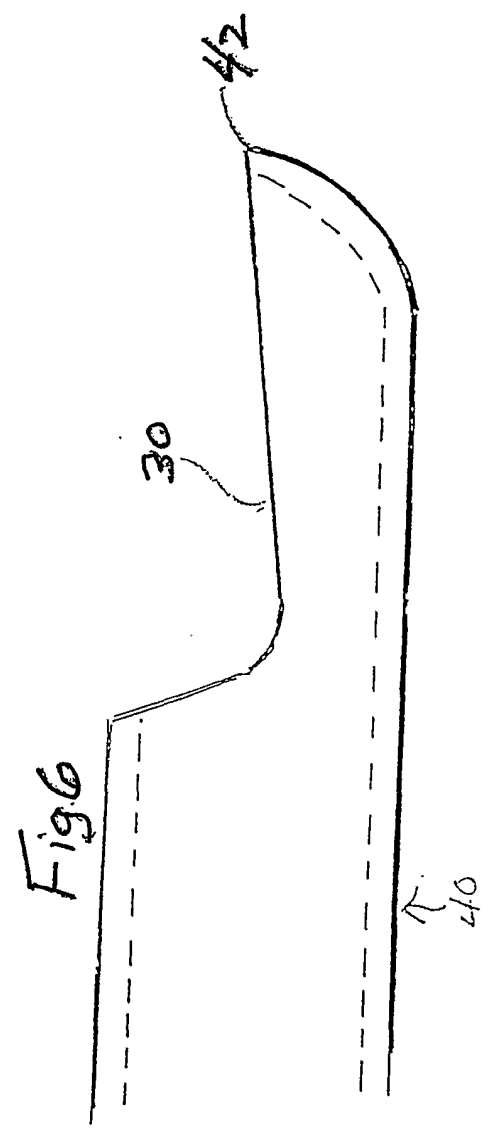

Fig. 19.7



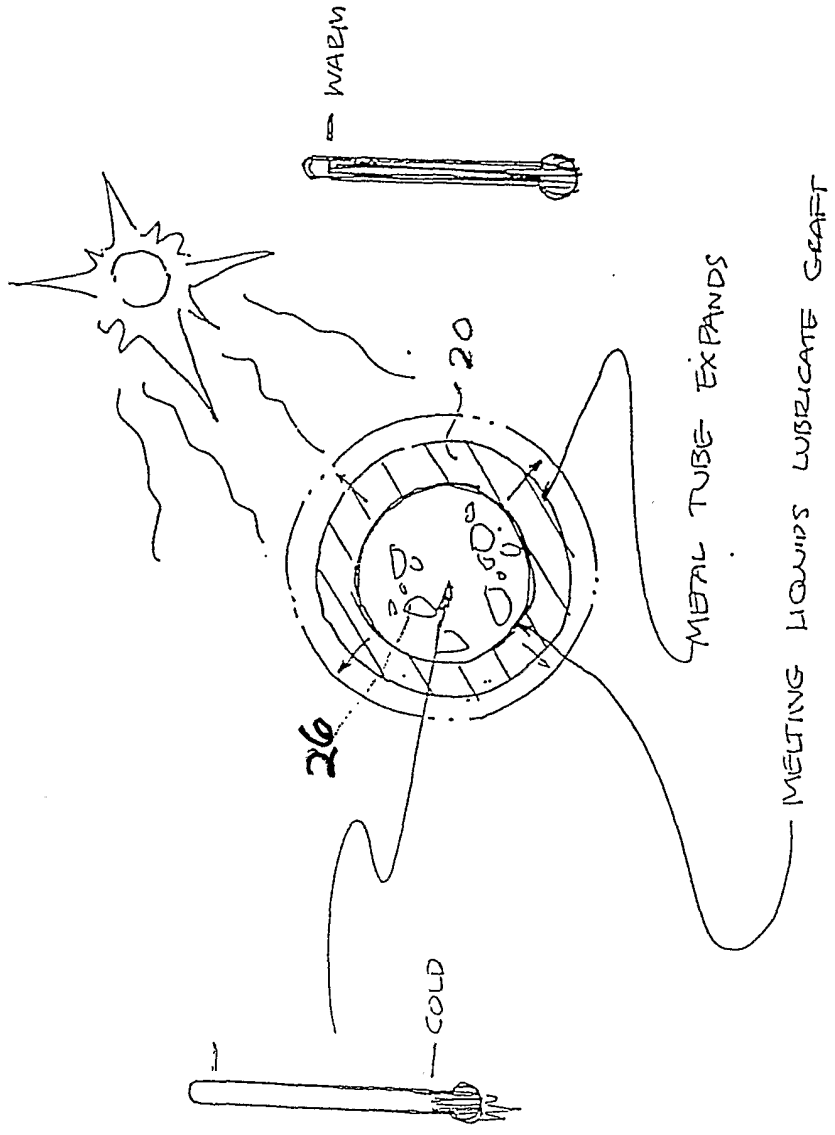
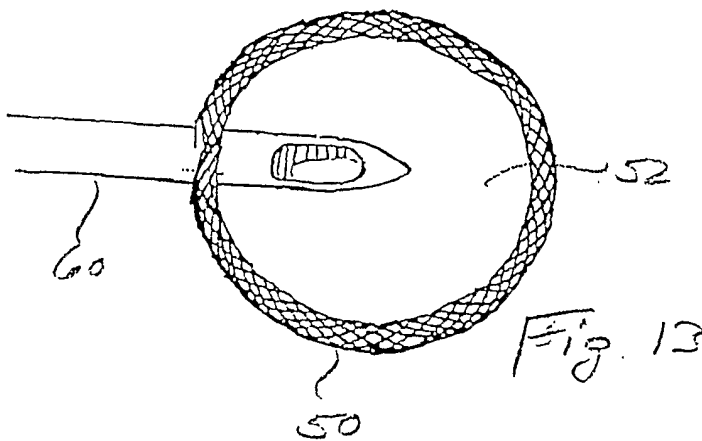
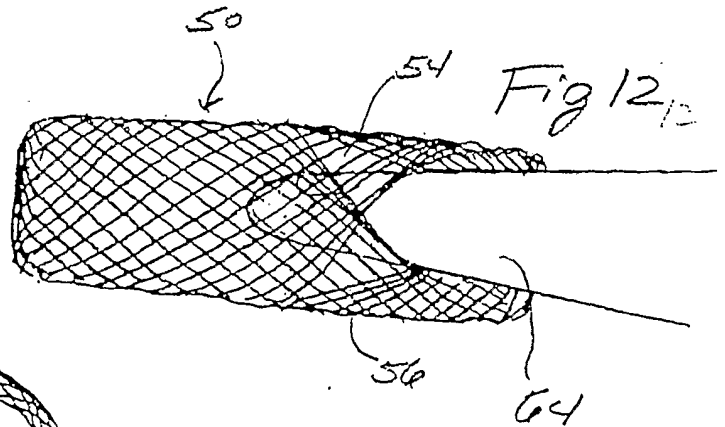
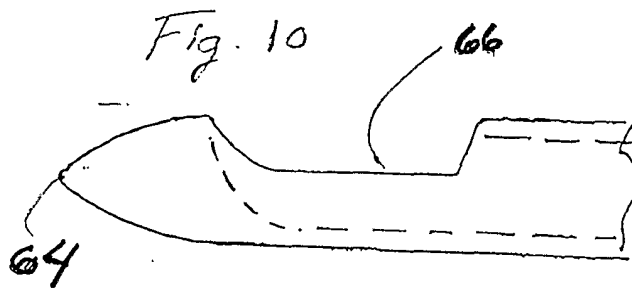
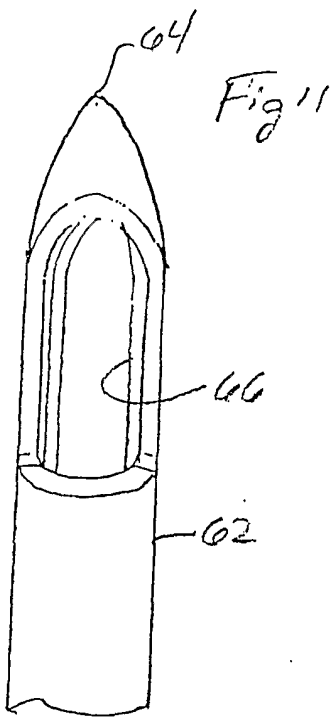
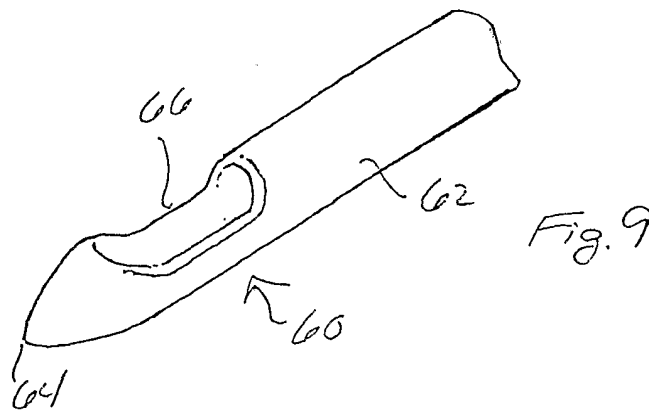

Fig. 8



INTERNATIONAL SEARCH REPORT

Inter | Application No
PCT/US 01/41256A. CLASSIFICATION OF SUBJECT MATTER
IPC 7 A61B17/34 A61F2/46 A61F2/44

According to International Patent Classification (IPC) or to both national classification and IPC

B. FIELDS SEARCHED

Minimum documentation searched (classification system followed by classification symbols)
IPC 7 A61B A61F A61M

Documentation searched other than minimum documentation to the extent that such documents are included in the fields searched

Electronic data base consulted during the international search (name of data base and, where practical, search terms used)

EPO-Internal, WPI Data, PAJ

C. DOCUMENTS CONSIDERED TO BE RELEVANT

Category °	Citation of document, with indication, where appropriate, of the relevant passages	Relevant to claim No.
X	WO 99 08616 A (KYPHON INC) 25 February 1999 (1999-02-25) page 16, line 17 -page 17, line 15 claims; figures 12,13 ---	1
X	US 4 653 487 A (MAALE GERHARD E) 31 March 1987 (1987-03-31) claims; figures ---	1
X	WO 00 28907 A (HARRINGTON ARTHRITIS RES) 25 May 2000 (2000-05-25) claims 1-4; figures 4-10 ---	1
A	DE 39 43 485 C (DR NOLDE MARTIN ET AL) 8 November 1990 (1990-11-08) claims; figures ---	1-6
	-/--	

 Further documents are listed in the continuation of box C. Patent family members are listed in annex.

° Special categories of cited documents:

- *A* document defining the general state of the art which is not considered to be of particular relevance
- *E* earlier document but published on or after the international filing date
- *L* document which may throw doubts on priority claim(s) or which is cited to establish the publication date of another citation or other special reason (as specified)
- *O* document referring to an oral disclosure, use, exhibition or other means
- *P* document published prior to the international filing date but later than the priority date claimed

- *T* later document published after the international filing date or priority date and not in conflict with the application but cited to understand the principle or theory underlying the invention
- *X* document of particular relevance; the claimed invention cannot be considered novel or cannot be considered to involve an inventive step when the document is taken alone
- *Y* document of particular relevance; the claimed invention cannot be considered to involve an inventive step when the document is combined with one or more other such documents, such combination being obvious to a person skilled in the art.
- * & * document member of the same patent family

Date of the actual completion of the international search

28 March 2002

Date of mailing of the international search report

09/04/2002

Name and mailing address of the ISA

European Patent Office, P.B. 5818 Patentlaan 2
NL - 2280 HV Rijswijk
Tel. (+31-70) 340-2040, Tx. 31 651 epo nl,
Fax: (+31-70) 340-3016

Authorized officer

Kuehne, H-C

INTERNATIONAL SEARCH REPORT

Inter | Application No
PCT/US 01/41256

C.(Continuation) DOCUMENTS CONSIDERED TO BE RELEVANT		
Category °	Citation of document, with indication, where appropriate, of the relevant passages	Relevant to claim No.
A	WO 99 65432 A (SJAARDA RAYMOND) 23 December 1999 (1999-12-23) claims; figures ---	1-6
A	DE 299 08 794 U (MEDIMEX HOLFELD GMBH & CO) 22 July 1999 (1999-07-22) claims; figures ---	1-6
A	GB 2 262 238 A (AGLAN MAGDY YASSIN ET AL) 16 June 1993 (1993-06-16) claims; figures -----	1-6

INTERNATIONAL SEARCH REPORT

Int. Application No
PCT/US 01/41256

Patent document cited in search report		Publication date	Patent family member(s)	Publication date
WO 9908616	A	25-02-1999	US 6048346 A AU 7711198 A CN 1276711 T EP 1003433 A1 JP 2001514922 T WO 9908616 A1	11-04-2000 08-03-1999 13-12-2000 31-05-2000 18-09-2001 25-02-1999
US 4653487	A	31-03-1987	NONE	
WO 0028907	A	25-05-2000	US 6214012 B1 EP 1128774 A1 WO 0028907 A1	10-04-2001 05-09-2001 25-05-2000
DE 3943485	C	08-11-1990	DE 3922203 C1 DE 3943485 C1 WO 9100713 A1 EP 0480954 A1	25-10-1990 08-11-1990 24-01-1991 22-04-1992
WO 9965432	A	23-12-1999	AU 4823399 A WO 9965432 A1	05-01-2000 23-12-1999
DE 29908794	U	22-07-1999	DE 29908794 U1	22-07-1999
GB 2262238	A	16-06-1993	NONE	